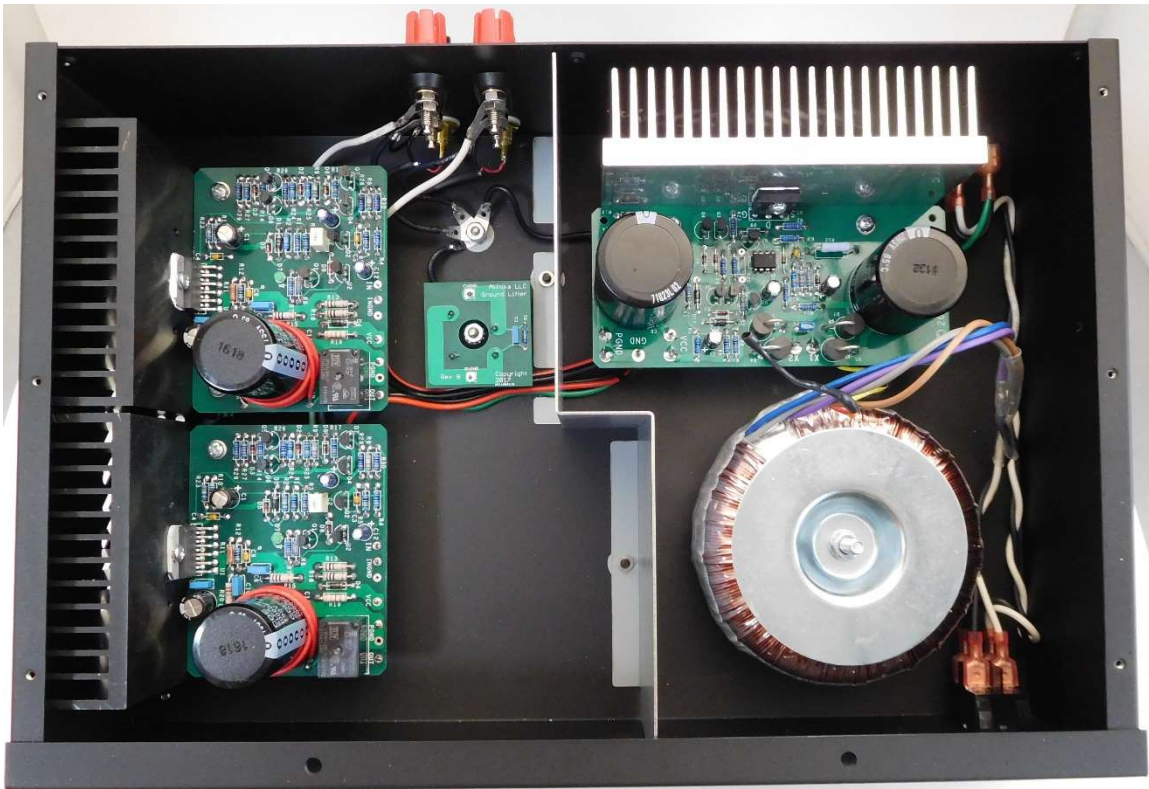


# Akitika

## ***GT-102 STEREO AUDIO POWER AMPLIFIER Z4 Version ASSEMBLY MANUAL***



© 2017-2024 Akitika LLC  
All rights reserved  
Revision 1p06      April 6, 2024

## Table of Contents

Table of Contents .....	2
Table of Figures .....	3
Section 1: About This Manual .....	5
Who Should Attempt this Project? .....	5
Tools You'll Need.....	5
Project Overview .....	5
Important Safety Notes .....	6
About Components .....	6
Recommended Solder .....	6
Warranty .....	6
Section 2: Building the Power Supply PCB .....	7
Component Order.....	7
Install the Resistors .....	7
Install the Diodes .....	9
Identifying the glass body diodes .....	9
Install the Last Resistor.....	10
Install the Small Capacitors .....	11
Install the Integrated Circuits.....	11
Install the Transistors.....	11
Install the Big Capacitors.....	12
Final Inspection of the Circuit Board.....	12
Power Supply Final Assembly.....	12
Section 3: Assembling the Amplifier Circuit Boards .....	15
Install the Resistors .....	16
Install the Small Capacitors and the Diodes .....	18
Last Capacitors and the Transistors .....	19
Winding the Output Inductor .....	21
Install Relay K1 .....	22
Final Inspection of the Circuit Board.....	22
Install the LM3866 and Mount the Amplifier Board to the Heatsink.....	23
Section 4: Wiring it All Together .....	25
Attach the Power Supply Ground Wire .....	25
Attach the Amplifier Module Wires .....	25
Attaching LEFT Module Wires .....	26
Attaching RIGHT Module Wires.....	26
Build the Ground Harnesses .....	27
Build the Ground Lifter .....	28
Install the Feet.....	29
AC Power Wiring .....	29
Installing Amplifier Modules into the Chassis .....	32
Install the Speaker Binding Posts .....	33
Connect the Speaker Binding Posts .....	34
Transformer Preparation .....	35
Transformer Installation.....	36

Testing the Power Supply .....	37
Final Amplifier Wiring .....	38
Wiring Amplifier Power .....	39
Fasten the Power Supply to the Chassis .....	39
Install the Wall and Fasten the Transformer Down .....	40
Visual Inspection .....	41
Section 5: Testing It Out and Installing the Top.....	41
Power-Off Tests .....	41
Power-On Tests.....	42
Install the Top and the Z4 Label.....	42
Section 6: Using the GT-102 .....	42
Section 7: Specifications and Schematics.....	43
Section 8: Theory of Operation.....	47
Power Supply .....	47
Bulk DC Supply.....	47
Pass Transistor .....	47
Regulator Control Circuits and their Power Supply .....	47
Current Limiting .....	47
Start-up Circuits.....	48
Amplifier Modules.....	48
Reference Voltage Generator.....	49
Gain Setting Circuits.....	49
Relay Control Circuit.....	49
Appendix 1 - Resistor Color Code.....	50
Appendix 2 - Preparing a Shielded Cable End .....	51

## Table of Figures

Figure 1-Component side of power supply PCB before loading.....	7
Figure 2-Installing resistors .....	8
Figure 3-Form the cathodes of D4-D7 as shown (banded end denotes cathode) .....	10
Figure 4-Pinout of U1, viewed from the top. Pin 1 is shown by either u-shaped mark or circle.....	11
Figure 5-Note the rounded brackets used for the power supply heatsink and PCB .....	12
Figure 6-Placing thermal compound on Q5.....	13
Figure 7-Installing Q5 on the heatsink and to the PCB .....	13
Figure 8-Remember to solder Q5's leads .....	14
Figure 9-Assembled Power supply mounted on heat sink.....	14
Figure 10-Component location guide for amplifier PCB's .....	15
Figure 11-Empty the amplifier components into a soup bowl.....	15
Figure 12-Close-up of Amplifier board prior to U1, K1, and L1 installation .....	16
Figure 13-Four of the same value resistors are installed, leads bent on the back side, then soldered and clipped. ....	17
Figure 14-showing LED cathode orientation.....	19
Figure 15-Starting to wind the output inductor.....	21
Figure 16-finishing step for the output inductor .....	22
Figure 17-Mounting assembled PCB to heat sink .....	23

Figure 18-mounting the PCB to the heat sink.....	23
Figure 19-Spread a thin film of thermal compound on the LM3886, but keep it off the leads .....	24
Figure 20-a completed amplifier module.....	24
Figure 21-from left to right, #6 lug, #10 lug, RCA connector ground lug .....	25
Figure 22-power supply with attached ground wire .....	25
Figure 23-shielded cable for left channel. Right channel has overall length of 11 inches. ....	26
Figure 24-Channel Grounding Harness .....	27
Figure 25-Ground Lifter PC Board.....	28
Figure 26-Ground Lifter PCB with ground wires connected.....	29
Figure 27-Install the feet here .....	29
Figure 28-FASTON connector .....	29
Figure 29-Wiring IEC power connector line and neutral .....	30
Figure 30-Power wiring with IEC connector installed into chassis.....	31
Figure 31-Installing power wires on the switch.....	31
Figure 32-spread thermal compound on the 1/4" wide edge .....	32
Figure 33-Installing RCA jacks .....	32
Figure 34-Install both left and right binding posts.....	33
Figure 35-I/O Connector wiring .....	34
Figure 36-Wiring toroidal transformer for 120 Volt operation .....	35
Figure 37-Western Union splice has diameter less than the insulated wires and no sharp points.....	36
Figure 38-connecting up the power transformer.....	37
Figure 39-Showing active and storage locations in the fuse drawer .....	38
Figure 40-Grounding Stud Detail .....	40
Figure 41-Routing the wires thru the slots in the wall.....	40
Figure 42-Toroidal Transformer Mounting .....	41
Figure 43-Power Supply Schematic.....	44
Figure 44-Amplifier Module Schematic.....	45
Figure 45-Overall Wiring (power transformer is wired for 120 VAC) .....	46
Figure 46-demonstrating the resistor color code .....	50
Figure 47- Shield wire end prep completed.....	52

## **Section 1: About This Manual**

This manual gives the information you need to build the Z4 version of Akitika LLC's GT-102 Stereo Power Amplifier. The Z4 version is optimized for 4 Ohm loads. It will deliver more than 50 Watts per channel to 4 Ohm speakers. Please note that the original version of the GT-102 is optimized for 8 Ohm loads, and it delivers more than 50 Watts per channel to 8 Ohm speakers.

### ***Who Should Attempt this Project?***

You can build this kit if you can:

1. solder (using normal rosin core solder and a soldering iron).
2. use simple hand tools like screwdrivers, wire cutters, and pliers.
3. read and follow directions.

It helps if you:

1. know a bit about electronics, or
2. have a friend who knows a bit about electronics
3. can get to YouTube to watch a few helpful videos about the assembly process

### ***Tools You'll Need***

You'll need the following tools:

1. Phillips screwdriver (#1 and #2)
2. pliers or nut drivers suitable for #6 hardware (5/16" nut driver or hex wrench).  
Note that the 5/16" nut driver is also the correct size for the speaker binding post nuts.
3. needle nose pliers (helpful, but not strictly necessary)
4. pencil type soldering iron of 25 to 50 Watts (no huge honking soldering guns or blowtorches)
5. wire cutters and strippers
6. multi-meter (strongly recommended to check resistor values!)
7. magnifying glass, if you're over 42!

### ***Project Overview***

The project consists of the following steps:

1. Build the Power Supply Regulator Board
2. Build left and right channel amplifier circuit boards.
3. Install and wire the circuit boards, switches, and connectors into the chassis.

## ***Important Safety Notes***

By purchasing, using, or assembling this kit, you have agreed to hold Akitika, LLC harmless for any injuries you may receive in its assembly and/or use. To prevent injuries:

- Wear safety glasses when soldering to prevent eye injuries.
- Always unplug the power before working on the amplifier.
- Large capacitors hold lots of energy for a long time. Before you put your hands into the amplifier:
  - Pull the AC plug!
  - Wait 2 full minutes for the capacitors to discharge!
- Remove jewelry and rings from your hands and wrists, or anything that might dangle into the amplifier.
- If working in the amplifier, keep one hand in your pocket, especially if you're near the power supply or power supply wires. This can prevent serious shocks.
- Build with a buddy nearby. If you've ignored all the previous advice, they can dial 911 or get you to the hospital.

## ***About Components***

We reserve the right to make design and/or component changes at any time without prior notification.

## ***Recommended Solder***

The kit must be assembled with 63/37 (tin/lead) Rosin Core solder<sup>1</sup>. The recommended diameter is 0.031 inches. Kester p/n 24-6337-8800 solder is a very good choice.

## ***Warranty***

With the exception of fuses, Akitika will replace for free any parts of a correctly assembled GT-102 that fail within one year of the date of purchase when the amplifier has been used in home stereo applications. It is the responsibility of the kit builder to install the replacement part(s). This warranty applies to the original purchaser only. It does not apply to units that have been physically or electrically abused, modified without prior factory authorization, or assembled with other than 63/37 Rosin Core solder. Akitika LLC's liability shall in no event exceed the cost paid to Akitika LLC for the kit.

---

<sup>1</sup> [https://en.wikibooks.org/wiki/Practical\\_Electronics/Soldering](https://en.wikibooks.org/wiki/Practical_Electronics/Soldering) has entries for both 60/40 and 63/37 solder blends. This reference calls out a preference for 63/37 because it is a eutectic solder, which it says is less prone to cold solder joints.

## Section 2: Building the Power Supply PCB

This section details the process of building the power supply circuit board. We start with an overview on this page. The specifics you need to start building begin on the next page.

The bare power supply PCB is shown in Figure 1.

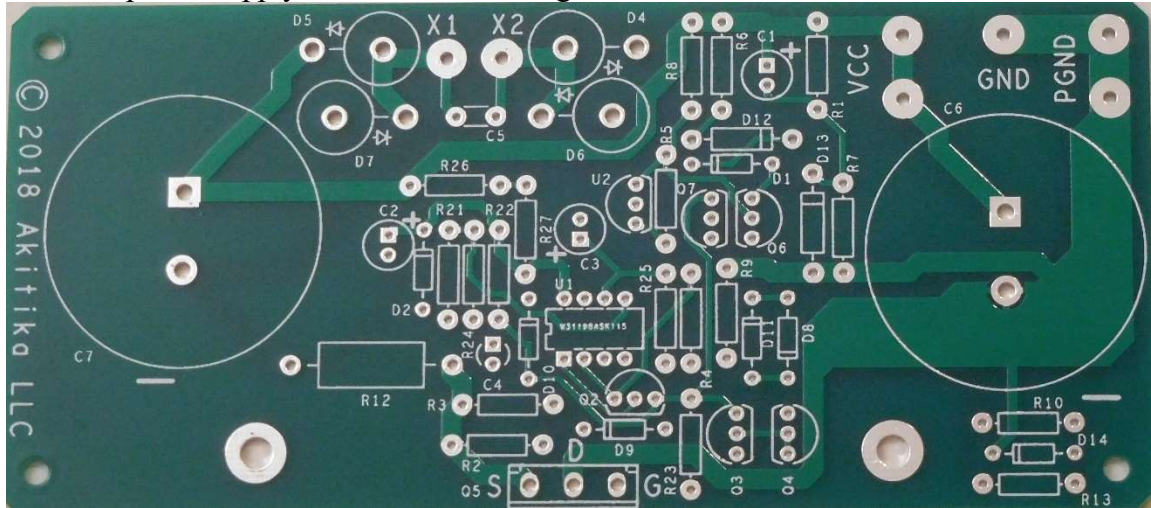


Figure 1-Component side of power supply PCB before loading

Begin by carefully emptying the contents of the envelope marked “GT-102 PSU Module” into a broad soup bowl, as shown below. In general, you’ll start with the components that lay closest to the board, working your way towards the taller components. You will:

1. Install the resistors (all but one power resistor, left for later)
2. Install the diodes
3. Install the capacitors
4. Install the integrated circuits.
5. Install the transistors
6. Install the pass transistor Q5 as you mount the PCB to the heat sink.



### Component Order

You’ll notice that the component designations in the directions don’t go exactly in order. We have grouped them so that all components with the same value appear together. This makes assembly easier. You’ll find in the parts kit that similar parts, e.g. 3 1K resistors, are typically (though not always) taped together.

### Install the Resistors

In general, you install the resistors by placing the body on the silk screen side of the board, and the leads through the indicated holes. Bend the leads over on the back of the board to keep the resistors from falling out until your solder them in place. Try to bend the leads in a direction that won’t lead to solder bridges between traces that should remain disconnected.

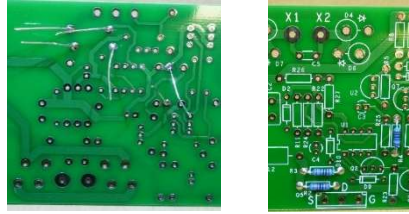


Figure 2-Installing resistors

We recommend the following procedure:

1. Insert all the resistors of the same value, e.g. R2, R3 and R4.
2. Bend the leads as described above.
3. Solder the leads on the back of the board.
4. Clip the leads.

Track your progress by placing a check-mark in the done column as you install each resistor. ***Check resistor values with a meter***, and by reading the color code (See Appendix 1). Orient the resistor with the fat brown band on the right, then you can read both the Color Code column and the resistor from left to right.

The 4Z version has some different part values compared to the original version. Those different values are part of the 4Z kit envelope. Components marked with a star(\*) will be pulled from the 4Z kit. This will leave you with a few extra parts that will not be used, those parts were a part of the original GT-102 kit.

¼ Watt, 1% resistors (if you use a lead-bending jig, use the 0.45" width)			
Designation	Value	Color code	Done? (✓)
R2	1K	Brown, Black, Black, Brown, Brown	
R3	3K48	Orange, Yellow, Gray, Brown, Brown	
R4	1K	Brown, Black, Black, Brown, Brown	
R6	10K	Brown, Black, Black, Red, Brown	
R26*	6K81	Blue, Gray, Brown, Brown, Brown	
R27*	6K81	Blue, Gray, Brown, Brown, Brown	
R8	20K	Red, Black, Black, Red, Brown	
R9	20K	Red, Black, Black, Red, Brown	
R1	15K	Brown, Green, Black, Red, Brown	
R5*	105K	Brown, Black, Green, Orange, Brown	R5
R7	5K76	Green, Violet, Blue, Brown, Brown	
R10	26K1	Red, Blue, Brown, Red, Brown	
R21*	4K99	Yellow, White, White, Brown, Brown	R21
R13	3M01	Orange, Black, Brown, Yellow, Brown	
R22 <sup>2</sup>	120K	Brown, Red, Black, Orange, Brown	
R23	100	Brown, Black, Black, Black, Brown	
R24	95K3	White, Green, Orange, Red, Brown	
R25		This location remains empty	

We will defer installation of R12, a 0.1 Ohm power resistor, for a bit later in the assembly process.

<sup>2</sup> R22 was 165K in earlier production. The change to 120K produces more consistent time to relay closure of about 8 seconds after power-up.



## Install the Diodes

Now install the diodes. Be careful to observe the polarity markings on the diodes. You'll notice that one end of the diodes has a band. That band indicates the cathode of the diode. Match the banded end of the diode with the banded end of the silk screen. The following information should help you identify the diodes.




### Identifying the glass body diodes

The glass body diodes have the following identifying marks. If your vision is like mine, you may need good light and a magnifying glass.

- 1N4148, D8-D11, has the number 48 visible
- BZX55B33B, D1 and D14, has the number 33 visible
- BZX79-B10, D2, has the number 10 visible

Also, typically when these diodes are packed, you can preliminarily identify the types because:

- The 4 1N4148 diodes will typically be taped together
- The 2 BZX55B33B diodes will typically be taped together
- The 1 BZX79-B10 diode will be by itself

		
D4-D7, opaque black plastic package	D12, D13, package type DO-41, opaque black plastic package	D1, D2, D8-D11, D14, package type DO-35, glass package

Keep track of the diodes as you install them using the following table. Remember to watch the polarity of the diodes, matching the banded end of the diode to the banded end of the silk screen.

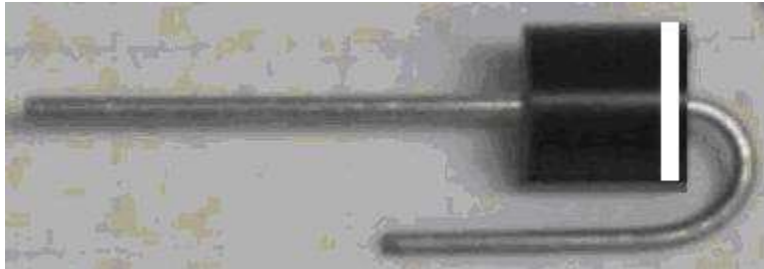
The 4Z version has some different part values compared to the original version. Those different values are part of the 4Z kit envelope. Components marked with a star (\*) will be pulled from the 4Z kit. This will leave you with a few extra parts that will not be used, those parts were a part of the original GT-102 kit.

Designation	Type, Package	Description	Done? (✓)
D1*	BZX55B20, DO-35	20 Volt 2% zener diode	
D14	BZX55B33, DO-35	33 Volt 2% zener diode	
D2	BZX79-B10, DO-35	10 Volt 2% zener diode	

D8	1N4148, DO-35	0.2 A, 100 PIV, switching diode	
D9	1N4148, DO-35	0.2 A, 100 PIV, switching diode	
D10	1N4148, DO-35	0.2 A, 100 PIV, switching diode	
D11	1N4148, DO-35	0.2 A, 100 PIV, switching diode	
D12	1N4004, DO-41	1A, 400 PIV, rectifier diode	
D13	1N4004, DO-41	1A, 400 PIV, rectifier diode	

**Warning: Don't cut the leads of D4-D7 until after the leads have been formed and the diodes have been soldered into the PCB.**

Form the leads of D4-D7 as shown in Figure 3. Solder one lead of each diode while attempting to keep the body perpendicular to the plane of the board. Ideally, the anodes of D4-D7 should sit about 1/8" to 1/16" off the board.



**Figure 3-Form the cathodes of D4-D7 as shown (banded end denotes cathode)**

Designation	Type, Package	Description	Done? (✓)
D4	6A4, R-6	6A, 400 PIV, rectifier diode	
D5	6A4, R-6	6A, 400 PIV, rectifier diode	
D6	6A4, R-6	6A, 400 PIV, rectifier diode	
D7	6A4, R-6	6A, 400 PIV, rectifier diode	

***Install the Last Resistor***

R12 should be air-mounted, with the bottom of its body about 1/8" above the PCB.

2 Watt, 5% resistor			
Designation	Value	Marking	Done? (✓)
R12	0.1	0.1	

## Install the Small Capacitors

Now install the small capacitors:

<i>C1, C2, and C3 are polarized, showing a minus sign (-) on the negative end of the capacitor. Make sure that the minus sign faces away from the plus sign (+) marked on the silk screen for each of the capacitors.</i>			
Designation	Value	Description	Done? (✓)
C1	10 $\mu$ F	100V electrolytic (polarized), cylindrical shape	
C2	10 $\mu$ F	100V electrolytic (polarized), cylindrical shape	
C3	10 $\mu$ F	100V electrolytic (polarized), cylindrical shape	
C4	100 nF	50V, Z5U, +/- 20%, marked 104	
C5	10 nF	400V, film, 20%, box shaped, marked 10nk400	

## Install the Integrated Circuits

Install the integrated circuits.

<i>Orient U1 so that pin 1 on the chip matches pin 1, the square pin, on the PCB. Orient U2 to match the silk screen outline.</i>			
Designation	Type	Description	Done? (✓)
U1	LM258 or LM358	8 Pin DIP	
U2	TL431, TO-92	Programmable shunt regulator	
Be careful! Don't confuse U2 with the transistors. Make sure you see "431" on U2.			

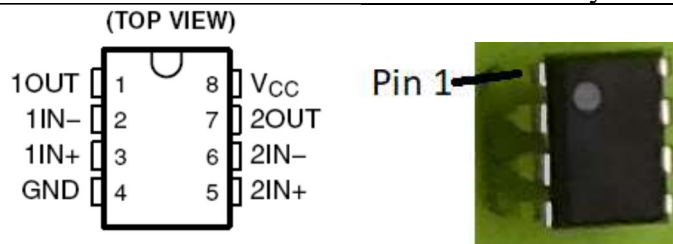


Figure 4-Pinout of U1, viewed from the top. Pin 1 is shown by either u-shaped mark or circle

## Install the Transistors

You may have to spread the outside leads a bit to make it easier to insert them into the board. Do not install Q5 now. It will be installed later.

<i>Orient the transistor so its body shape matches the silk-screen outline. Leave the top of the transistor about 1/2" off the board! The lead length prevents stress on the body and keeps the transistor safe from too much heat during the soldering operation.</i>			
Designation	Type	Description	Done? (✓)
Q2	2N3904, TO-92	60 V NPN bipolar transistor	
Q3	2N3904, TO-92	60 V NPN bipolar transistor	
Q4	2N3904, TO-92	60 V NPN bipolar transistor	
Q6	2N5401, TO-92	150 V PNP bipolar transistor	
Q7	2N5401, TO-92	150 V PNP bipolar transistor	

*Don't use too much solder on the transistor leads. This is one place where the spacing is close enough that extra solder might cause short circuit between two leads on a given transistor. Note that Q4's collector and base are connected by the circuit board.*

## **Install the Big Capacitors**

Install C6 and C7.

*C6 and C7 are polarized. Be careful to get the polarity correct. Double check their polarity before you solder them in place. They have large terminals, so it will take a fair amount of heat and solder.*

Designation	Type	Description	Done? (✓)
C6	10,000 $\mu$ F/80V	Electrolytic capacitor	
C7	6800 $\mu$ F/100V	Electrolytic capacitor	

**Caution: C6 and C7 are not identical! Be sure to put each in its correct place!**

## **Final Inspection of the Circuit Board**

After you've taken a break, look over your completed circuit board one more time.

Looking on the component side, double check:

1. polarity (banded end) of diodes matching the banded end on the silk screen.
2. polarity of C1, C2, C6, C7 and C7 (minus sign away from the indicated plus sign on the silk screen).

If you get one of these polarities wrong, there is a good chance that the power supply won't work, or there will be damage when you power it up.

Look at the solder side of the board. Make sure that:

1. All component leads are soldered (it's easy to forget one or two, and that will cause either unreliable operation, or no operation at all!)
2. There are no solder bridges between pads which should be isolated. Solder bridges may stop the power supply from working correctly.

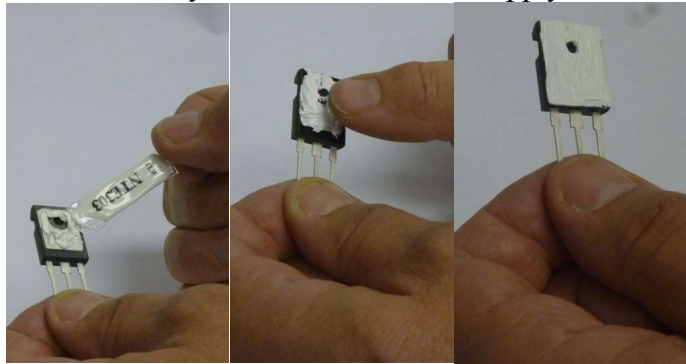
## **Power Supply Final Assembly**

In this section, you'll install Q5 while you mount the power supply circuit board on its heatsink. Some kits have a silver colored finned heatsink. Other kits have a black-anodized heat sink. In either case, the power supply heatsink is about 5 3/8" wide. The kit has two other heat sinks that that will be used for the amplifier modules. These heat sinks are black, and about 4" wide.

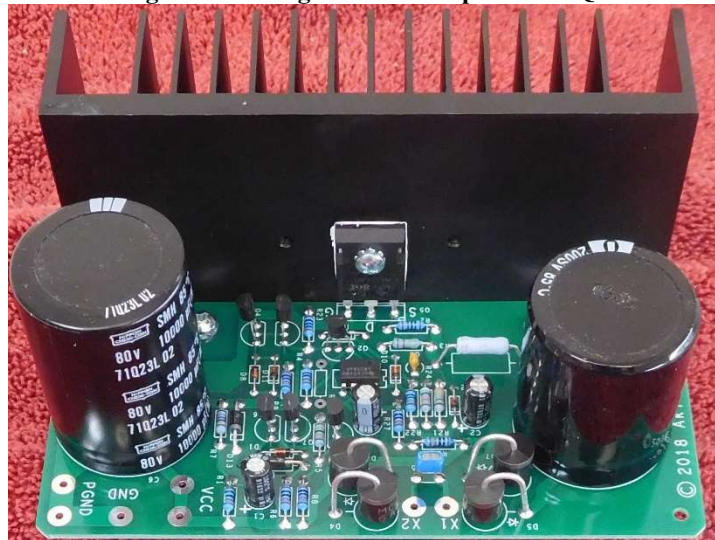


**Figure 5-Note the rounded brackets used for the power supply heatsink and PCB**

1. Use two 6-32x3/8" screws to fasten a pair of mounting brackets to the heat sink, placing the screw through the 9/64" clearance hole in the bracket. Note that one hole in the mounting bracket is a 9/64" clearance hole, the other hole is threaded to accept a 6/-32 screw. Don't tighten the screws yet. *Make sure you use the brackets with the rounded edges to mount the power supply PCB.*
2. Use two 6-32x1/4" screws to fasten the PCB to the mounting brackets and heat sink, see Figure 9. Don't tighten the screws yet.
3. Place a thin film of thermal compound on the metal tab surface of Q5 as shown in Figure 6. Inset Q5 into the circuit board as shown in Figure 7. Secure it in place with a #6-32x1/2" screw, just finger tight for now. The side with the thermal compound must attach to the heat sink.
4. The previous step uses just a small amount of the thermal compound in the squeeze tube. Put the squeeze tube in a safe place, as you may choose to use the rest of its contents when you Fasten the Power Supply to the Chassis.



**Figure 6-Placing thermal compound on Q5**



**Figure 7-Installing Q5 on the heatsink and to the PCB**



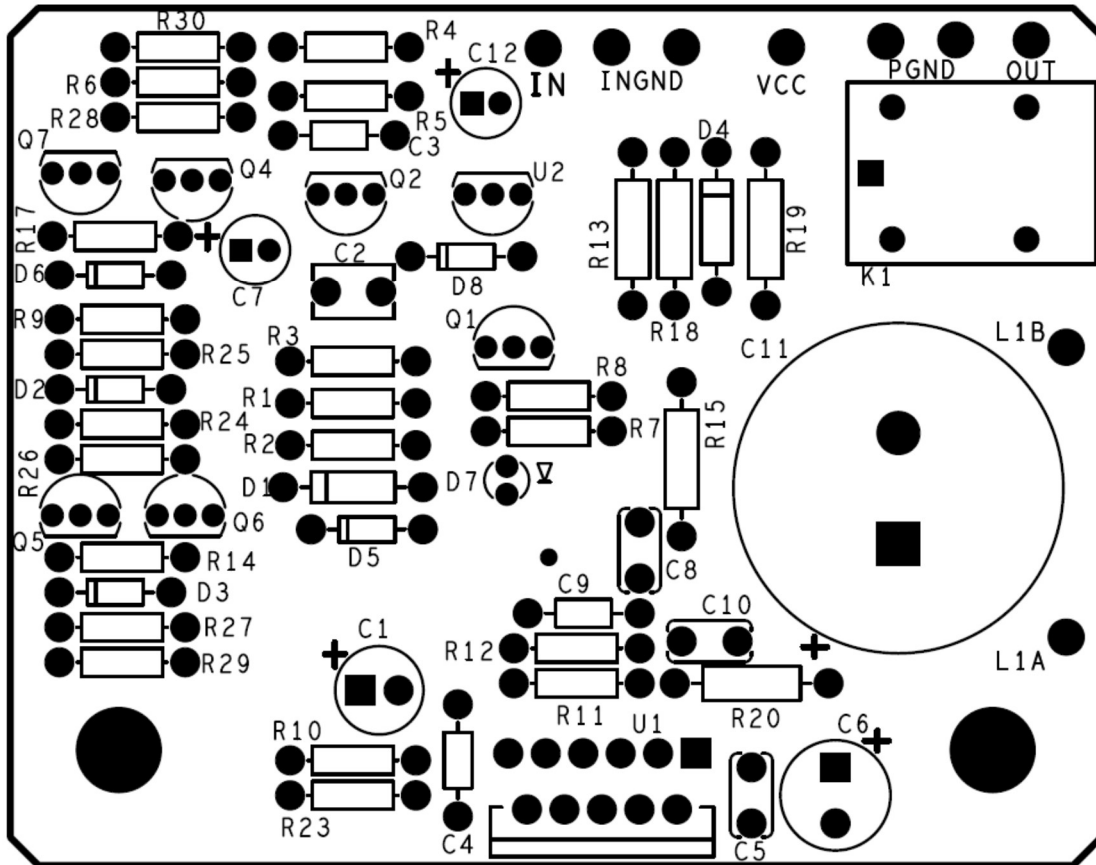


Figure 10-Component location guide for amplifier PCB's

### Section 3: Assembling the Amplifier Circuit Boards

This section details the process of building the amplifier module circuit boards. We start with an overview on this page. Begin by carefully emptying the contents of *one* of the envelopes marked “GT-102 Amplifier Module” into a broad soup bowl, as shown in Figure 11.

In general, you’ll start with the components that lay closest to the board, working your way toward the taller components. You will:

1. Install the resistors
2. Install the small capacitors
3. Install the diodes
4. Install the LED
5. Install the medium size capacitors
6. Install the transistors
7. Install the big capacitor
8. Wind and install the output inductor.
9. Install the relay.
10. Install the LM3886.



Figure 11-Empty the amplifier components into a soup bowl

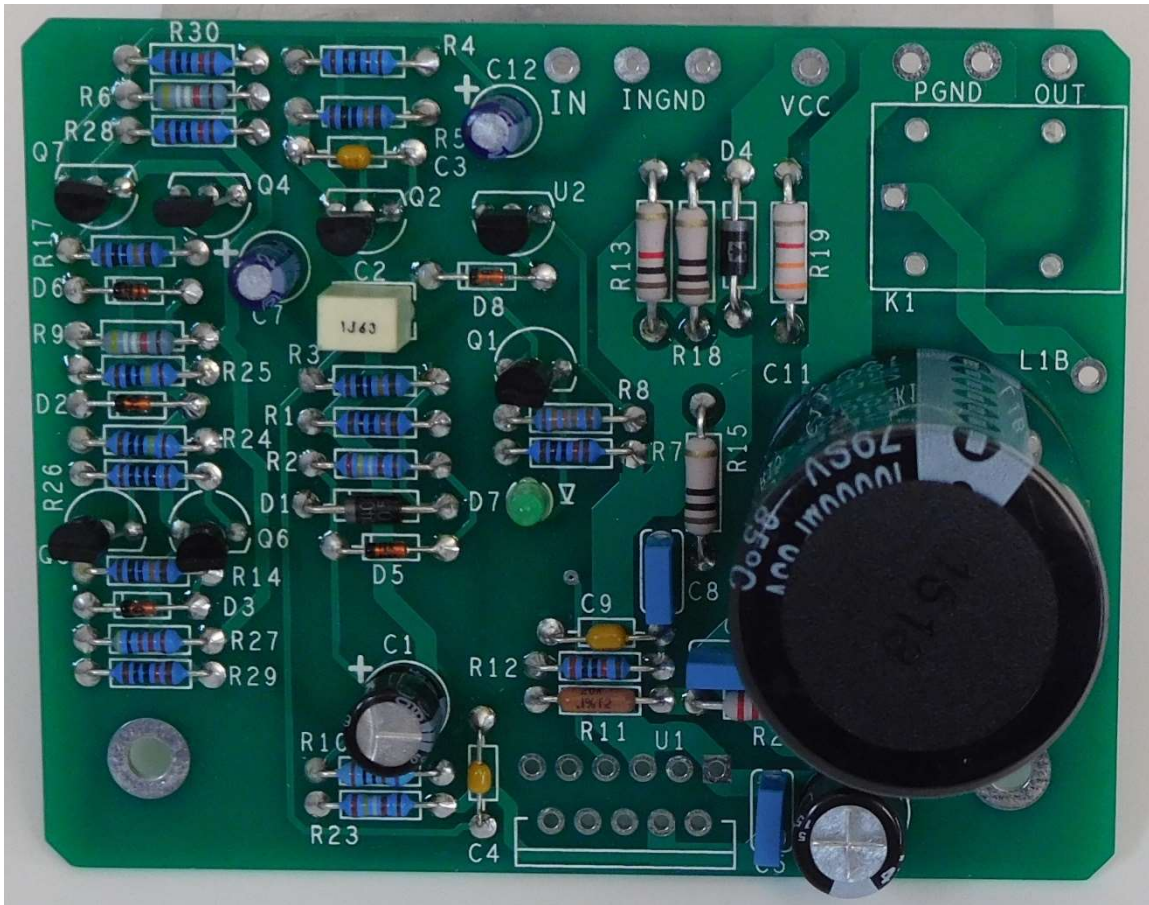


Figure 12-Close-up of Amplifier board prior to U1, K1, and L1 installation

### ***Install the Resistors***

In general, you install the resistors by placing the body on the silk screen side of the board, and the leads through the indicated holes. Bend the leads over on the back of the board to keep the resistors from falling out until your solder them in place. Try to bend the leads in a direction that won't lead to solder bridges between traces that should remain disconnected.

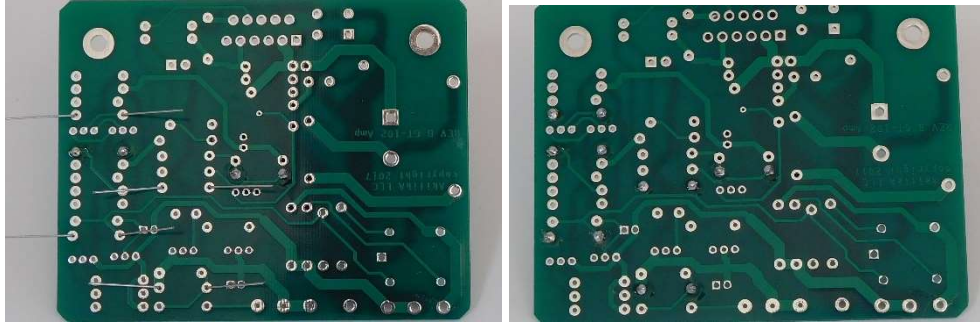
We recommend the following procedure:

1. Insert all the resistors of the same value, e.g. R14, R17, R3, and R5.
2. Bend the leads as described above.
3. Solder the leads on the back of the board.
4. Clip the leads.

To track your progress, place a checkmark in the done column as each resistor is installed. Check resistor values with a meter *and* by reading the color code. Orient the resistor with the fat brown band on the right, then you can read both the Color Code column and the resistor from left to right.

Assembly begins with installing the small (1/4 Watt) resistors, and will progress to the larger (higher wattage) resistors.





**Figure 13-Four of the same value resistors are installed, leads bent on the back side, then soldered and clipped.**

The 4Z version has some different part values compared to the original version. Those different values are part of the 4Z kit envelope. Components marked with a star (\*) will be pulled from the 4Z kit. This will leave you with a few extra parts that will not be used, those parts were a part of the original GT-102 kit.

*Important Notes:*

1. *The GT-102 is a dual channel amplifier. You will build two identical channels. We've provided two Done columns, Done1 for the first channel you build, and Done2 for the second channel. We recommend that you build the channels one at a time, completing the first channel, then returning to this point to build the second channel.*
2. *The kit contains two types of ¼ W 20K resistors, 1% tolerance, and 0.1% tolerance. See the description below to install each in its correct position.*
3. *The kit contains two types of ¼ W 1K resistors, 1% tolerance, and 0.1% tolerance. See the description below to install each in its correct position.*

Designation	Value	Color Code	Done 1	Done2
R26	100	Brown, Black, Black, Black, Brown		
R8*	105K	Brown, Black, Green, Orange, Brown		
R3	100K	Brown, Black, Black, Orange, Brown		
R5	100K	Brown, Black, Black, Orange, Brown		
R14	100K	Brown, Black, Black, Orange, Brown		
R17	100K	Brown, Black, Black, Orange, Brown		
R1	10K0	Brown, Black, Black, Red, Brown		
R7*	6K81	Blue, Gray, Brown, Brown, Brown		
R28	10K0	Brown, Black, Black, Red, Brown		
R29	10K0	Brown, Black, Black, Red, Brown		
R30	10K0	Brown, Black, Black, Red, Brown		
R4	1K	Brown, Black, Black, Brown, Brown		
R10	1K, 0.1%	Brown, Black, Black, Brown, Violet; In some kits, the resistor may have numbers: 1K 0.1% on a brown body		
R24	1M00	Brown, Black, Black, Yellow, Brown		
R25	1M00	Brown, Black, Black, Yellow, Brown		
R12	20K	Red, Black, Black, Red, Brown		

R11	20K, 0.1%	Red, Black, Black, Red, Violet In some kits, the resistor may have numbers: 20K 0.1% on a brown body.		
R2	24K9	Red, Yellow, White, Red, Brown		
R23	24K9	Red, Yellow, White, Red, Brown		
R27*	30K1	Orange, Black, Brown, Red, Brown		
R6	49K9	Yellow, White, White, Red, Brown		
R9	49K9	Yellow, White, White, Red, Brown		

The following resistors are 1-Watt resistors, having a larger body than the resistors installed in the previous section.

R13	1000 (1 Watt) 5%	Brown, Black, Red, Gold.		
R20	2.2 (1 Watt) 5%	Red, Red, Gold, Gold		
R19*	2200 (1 Watt) 5%	Red, Red, Red, Gold		
R15	10 (1 Watt) 5 %	Brown, Black, Black, Gold.		
R18	10 (1 Watt) 5%	Brown, Black, Black, Gold		

### **Install the Small Capacitors and the Diodes**

Now we'll install the following small capacitors:

Designation	Value	Marking	Done 1	Done 2
C3	220 pF	221		
C4	220 pF	221		
C9	47 pF	470, or 47J		

Here's what these three caps look like (not to scale):



Next we install all the diodes except for the LED, which is installed a bit later.

*Be careful! Diodes have a polarity. Make sure the band on the diode aligns with the banded end of the silk screen!*

Designation	Value	Marking, type	Done1	Done2
D1	1N4004	4004, 1 amp 400 V diode		
D4	1N4004	4004, 1 amp 400 V diode		
D5	TZX6V2C	6V2, 6.2 V Zener diode		
D2	BZX79-10	B10, 10 V Zener diode		
D3	BZX79-10	B10, 10 V Zener diode		
D8	BZX79-10	B10, 10 V Zener diode		
D6	1N4148	4148, switching diode		

Here's what the 1N4004 diodes look like (not to scale):



And the rest of the diodes, with the exception of the LED look like this:



Next, we install LED D7 (Light Emitting Diodes) – the green light from this LED will be of medium brightness, and thus visible in a normally lit room.

*Be careful! Light Emitting Diodes have a polarity, also! Read carefully to make sure you're putting the diodes in the right way!*

- For all LEDs, if the leads are uncut, the shorter of the two leads is the cathode.
- Some LEDs indicate the cathode with a bar (negative sign) molded into the package.
- Some LEDs have no bar, but seen from the top, the circular outline with have a flat side. That flat side is the cathode.

Designation	Value	Package	Done1	Done2
D7	LED	T1 LED package		

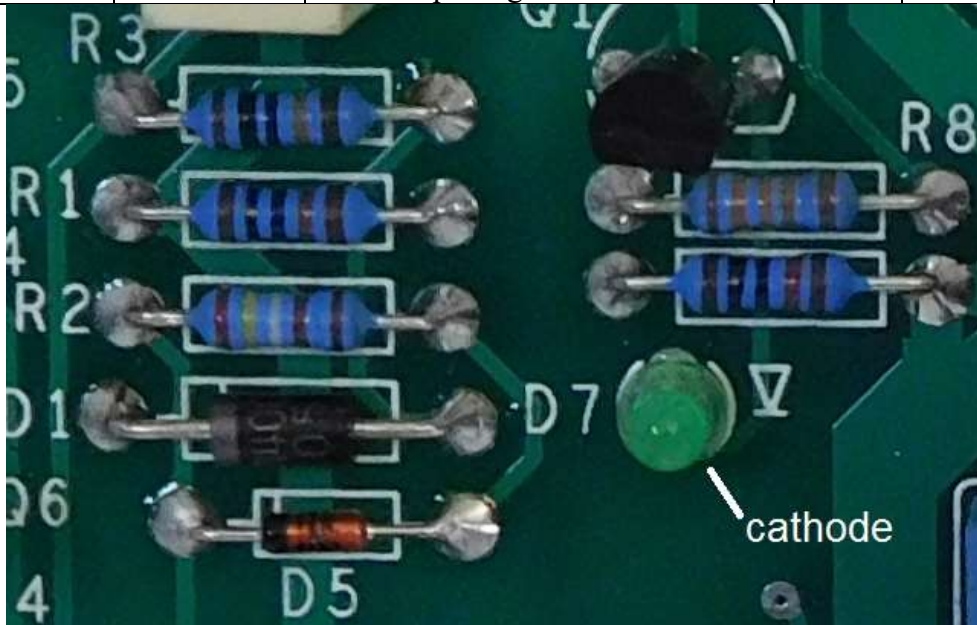


Figure 14-showing LED cathode orientation

### **Last Capacitors and the Transistors**

Now install the medium tall polarized electrolytic capacitors:

*C1, C6, C7, and C12 are polarized. Make sure the negative sign on the capacitors faces away from the positive sign on the silk screen!*

Designation	Value	Marking	Done 1	Done 2
C1	100 $\mu$ F, 50 V	100 $\mu$ F, 50 V, and minus sign for polarity		
C6	47 $\mu$ F, 100 V	47 $\mu$ F, 100 V, and minus sign for polarity		
C7	22 $\mu$ F, 50 V	22 $\mu$ F, 50 V, and minus sign for polarity		
C12	10 $\mu$ F, 50 V	10 $\mu$ F, 50 V, and minus sign for polarity		

Install the non-polarized capacitors. Either orientation is fine for these capacitors:

Designation	Value	Marking	Done 1	Done 2
C2	1 $\mu$ F, 63 V	105K, 63 V or 100V (box shaped mylar capacitor) May also be marked 1J63		
C5	0.1 $\mu$ F, 100V	$\mu$ 1J100, small blue box shape		
C8	0.1 $\mu$ F, 100V	$\mu$ 1J100, small blue box shape		
C10	0.1 $\mu$ F, 100V	$\mu$ 1J100, small blue box shape		

Install the voltage regulator. It is in a TO-92 package that looks just like the transistors that will be installed in the next section. Make sure to look for the identifying markings.

<i>Orient the TL431 so its body shape matches the silk-screen outline. Leave the top of the regulator about 1/2" off the board! The lead length prevents stress on the body and keeps the regulator safe from too much heat during the soldering operation.</i>				
Designation	Value	Marking, type	Done 1	Done 2
U2	TL431	431, 2.5 V programmable regulator		
<i>Don't confuse U2 with the transistors. Look for the "431" marking on U2.</i>				

Install the transistors. Spread the outside leads a bit to make it easier to insert them into the board. **Double check their marking before you install them.**

<i>Orient the transistor so its body shape matches the silk-screen outline. Leave the top of the transistor about 1/2" off the board! The lead length prevents stress on the body and keeps the transistor safe from too much heat during the soldering operation.</i>				
Designation	Value	Marking, type	Done 1	Done 2
Q1	2N5551	2N5551, NPN 150 Volt		
Q2	J176	176, P channel JFET		
Q4 <sup>3</sup>	ZVN2110A	2110, N Channel MOSFET 100 Volt		
Q5	2N3904	2N3904, NPN 40 volt		
Q6	2N3904	2N3904, NPN 40 volt		
Q7	2N3904	2N3904, NPN 40 volt		

Now install the speaker coupling capacitor:

<i>Watch the polarity! Make sure the minus sign faces the place where K1 will be installed a few steps from now.</i>				
Designation	Value	Marking	Done 1	Done 2
C11	10000 $\mu$ F 63V	10000 $\mu$ F, 63 WVDC		

<sup>3</sup>Viewed from the top of the package, be sure that the rounded edges of the package match the rounded edges on the silk screen.

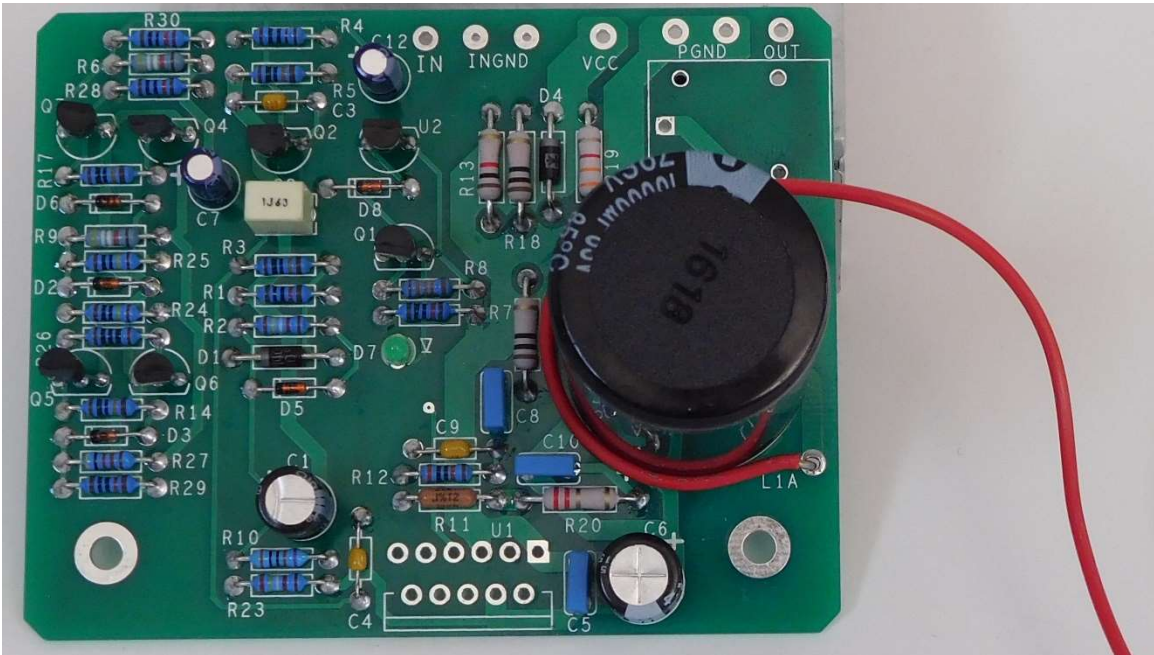
The speaker coupling capacitor will either snap or push into place. **Verify once more that you have polarity correct**, and then solder both terminals to the circuit board. This will probably take more heat, time, and solder than anything you have soldered up to now.

## **Winding the Output Inductor**

This step takes just a bit of finesse, but if you've come this far, you have nothing to worry about. If you're a bit frazzled, take a break before proceeding.

There...feel better? OK, let's go. Just follow these steps, **measuring the wire length carefully if you want to succeed the on first shot**.

1. Cut a 23  $\frac{3}{4}$ " length of 18 AWG solid wire supplied with the kit. (The color may vary from the photo. The length will be about 30", so you'll have to carefully measure and cut the wire).
2. Strip back  $\frac{3}{8}$ " of insulation from both ends of the wire. Be careful not to nick the conductors.
3. From the component side, place one stripped end of the wire into the L1A terminal. Bend it on the solder side to retain it, but don't solder it yet. Route it around the output capacitor as shown in Figure 15.
4. Wind 6 turns of wire, closely spaced, so it looks like Figure 16. When you get to the end of the coil, fold the end across the existing turns, toward the L1B hole.
5. Pull the end of the wire through the L1B hole, and solder it on the back of the board.
6. Solder the L1A side of the inductor.



**Figure 15-Starting to wind the output inductor**



**Figure 16-finished step for the output inductor**

### ***Install Relay K1***

It's important to get K1 installed flat onto the PCB. To do this:

1. Insert K1 through the PCB.
2. Solder one corner pin. Make sure the relay sits flat on the board. If it doesn't, push it in while you re-heat that pin.
3. Solder the opposite corner pin and check again that all the pins have come through the PCB, and that the relay body rests flat on the PCB.
4. Finish soldering all of the rest of K1's pins.

### ***Final Inspection of the Circuit Board***

After you've taken a break, look over your completed circuit board(s) one more time.

Looking on the component side, double check:

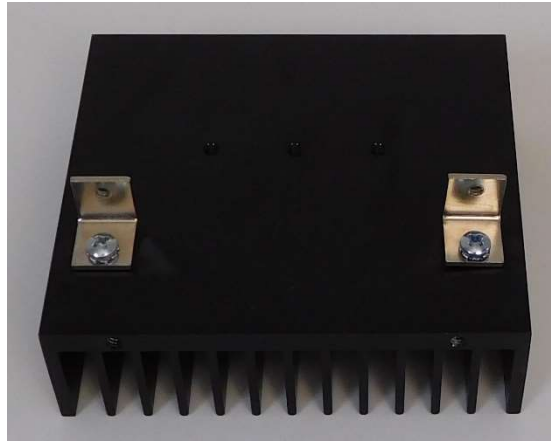
1. polarity of diodes matching the banded end on the silk screen.
2. polarity (flat end, or molded bar end) of LED D7.
3. polarity of C1 (minus sign away from the indicated plus sign on the silk screen).
4. polarity of C6 (minus sign away from the indicated plus sign on the silk screen).
5. polarity of C11 (minus sign close to relay K1).

If you get one of these polarities wrong, there is a good chance that the amplifier won't work, or there will be damage when you power it up.

Look at the solder side of the board. Make sure that:

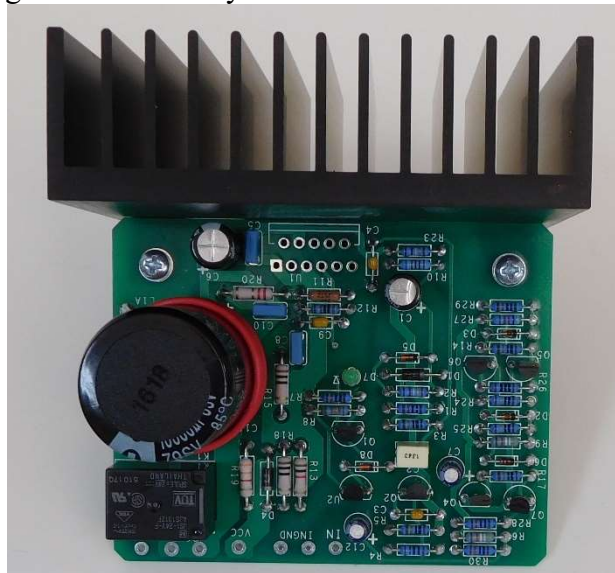
1. All component leads are soldered (it's easy to forget one or two, and that will cause either unreliable operation, or no operation at all!)
2. There are no solder bridges between pads which should be isolated. Solder bridges may stop the amplifier from working correctly.

## ***Install the LM3866 and Mount the Amplifier Board to the Heatsink***



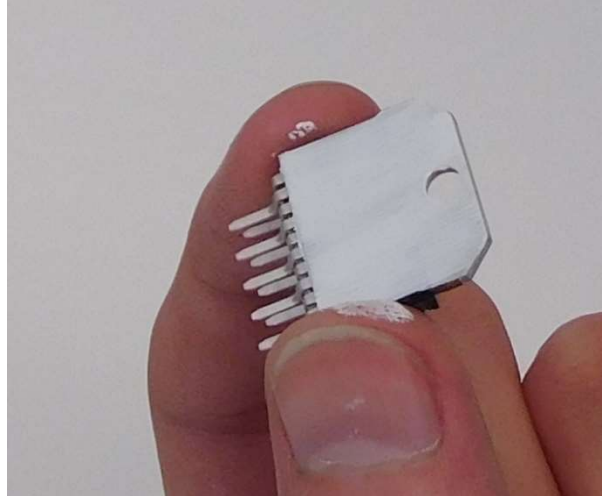
**Figure 17-Mounting assembled PCB to heat sink**

1. Use two 6-32x3/8" screws to fasten a pair of mounting brackets to the heat sink, placing the screw through the un-threaded hole in the bracket. Use the inner set of holes in the heatsink. Don't tighten the screws yet.
2. Use two 6-32x1/4" screws to fasten the PCB to the mounting brackets and heat sink. Don't tighten the screws yet.



**Figure 18-mounting the PCB to the heat sink**

3. Place a dab of thermal compound on the back of the LM3886 and spread it into a thin film, being careful to keep the leads clean. This step uses just a small amount of the thermal compound in the squeeze tube. Put the squeeze tube in a safe place, as you may choose to use the rest of its contents when you fasten the amplifier module to the chassis.



- Figure 19-Spread a thin film of thermal compound on the LM3886, but keep it off the leads**
4. Fasten the LM3886 to the heatsink using a 6-32x3/8" screw. Tighten all the mounting screws as you make sure that the LM3886 is perpendicular to the plane of the board.



**Figure 20-a completed amplifier module**

5. Remember to tilt the board up and solder the LM3886 pins on the solder side, as usual!
6. Inspect your soldering from both sides, making sure that there are no solder bridges between the leads of the LM3886.
7. You have just completed the first of two amplifier modules. Return to page 15 to repeat the process to build the amplifier module for the second channel.



## Section 4: Wiring it All Together

Get out your trusty soup bowl, and empty the contents of the “Top Level Hardware” envelope into it. The “GT-102 Wiring Kit” is packed in the chassis. It’s the source of all the wire used in this section. Remove the 11 small black phillips-head screws that hold the cover in place to retrieve the wiring kit.

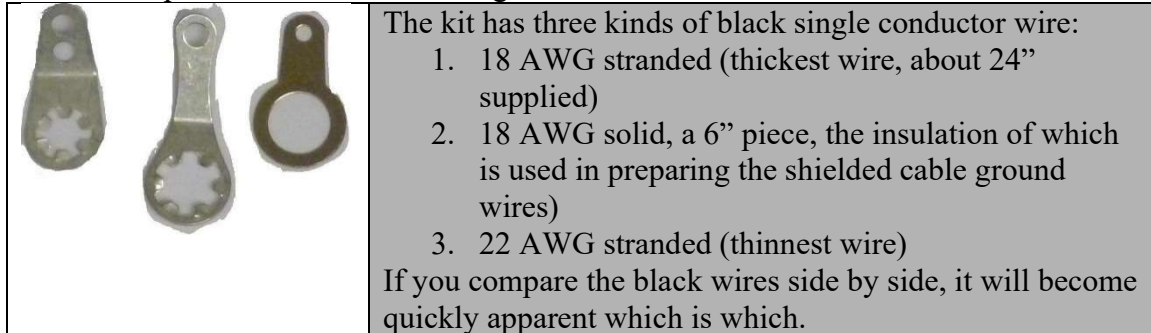


Figure 21—from left to right, #6 lug, #10 lug, RCA connector ground lug

### Attach the Power Supply Ground Wire

1. Cut a 7” length of black 18 AWG stranded wire. Strip 1/4” of insulation from both ends of the wire.
2. Insert one end of the wire into the GND eyelet (this is different from the PGND eyelets!) of the power supply PCB. Insert it from the solder side and solder it on the component side.
3. Tin the other end of the wire and insert it into the eyelet of a #6 lug. Crimp the wire and solder it to the lug.

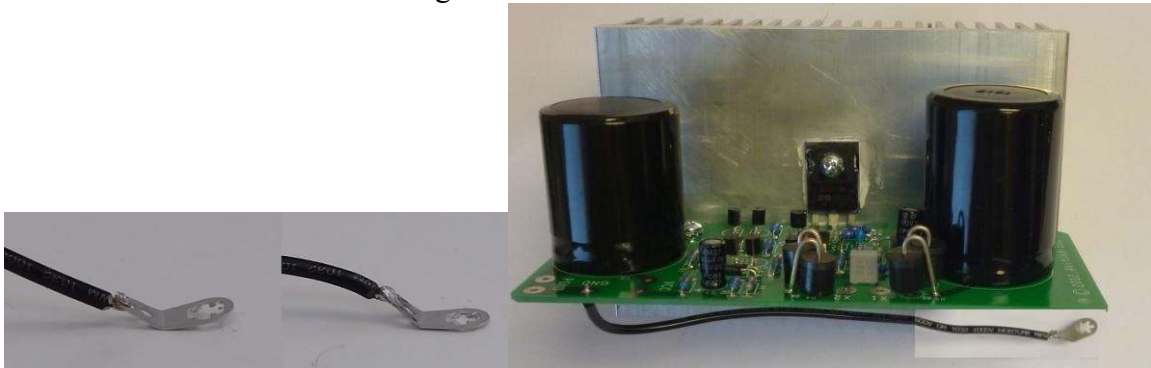


Figure 22—power supply with attached ground wire

Note: The X1, X2, VCC, and PGND eyelets will remain open until a later assembly step.

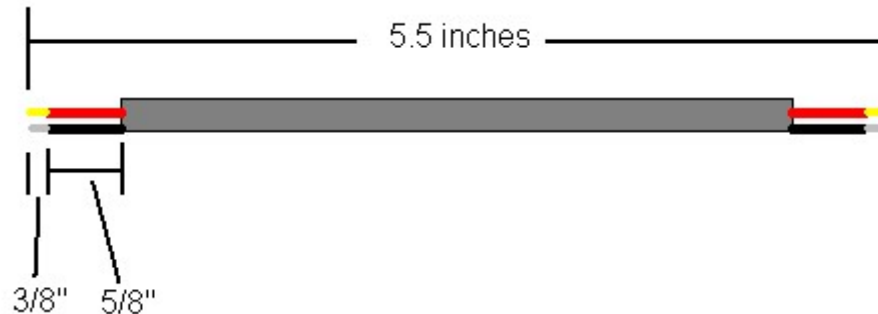
### Attach the Amplifier Module Wires

Designate one of the completed amplifier modules as LEFT, and the other as RIGHT. To prevent errors, it may help to make and apply LEFT and RIGHT masking tape labels to the amplifier modules.

*Orient the amplifier module wires that you are about to install perpendicular to the plane of the PCB for neatest wiring.*

## Attaching LEFT Module Wires

1. For the module designated as LEFT, cut a 9" overall length of Red/Black 18 AWG zip cord.
2. Separate the Red and Black wires about 1 inch at each end.
3. Remove about 1/4" of insulation from each of the four ends and tightly twist the copper strands together.
4. From one end of the Red/Black wire, insert the Red wire into the VCC eyelet, entering from the solder side. Solder the wire on the component side.
5. From that same end of the Red/Black wire, insert the Black wire into the PGND eyelet, entering from the solder side. Solder the wire on the component side.
6. Prepare a 5 1/2" length of shielded cable per the directions that begin on Page 51. Prepare both ends per those directions. Twist and tin the four ends of the cable.



**Figure 23-shielded cable for left channel. Right channel has overall length of 11 inches.**

7. Working with one end of the shielded cable, insert the red wire into the IN eyelet, inserting it from the solder side, and soldering it on the component side.
8. Working from that same end, insert the drain wire into the INGND eyelet closest to the IN eyelet. Once again, insert it from the solder side, and solder it on the component side.
9. Cut an 8" length of 18 AWG stranded white wire. Remove 1/4" of insulation from both ends.
10. Insert the first end of the white wire into the OUT eyelet of the PCB, inserting it from the solder side, and soldering it on the component side.
11. Tin the remaining end of the white wire and insert it through the eyelet of a #10 lug. To be sure you have the #10 lug, the toothed portion should slide over the screws in the Red and Black speaker binding posts.
12. Crimp the white wire on the lug, and solder it in place.

## Attaching RIGHT Module Wires

1. For the module designated as RIGHT, cut an 11" overall length of Red/Black 18 AWG zip cord.
2. Separate the Red and Black wires about 1 inch at each end.
3. Remove about 1/4" of insulation from each of the four ends and tightly twist the copper strands together.
4. From one end of the Red/Black wire, insert the Red wire into the VCC eyelet, entering from the solder side. Solder the wire on the component side.
5. From that same end of the Red/Black wire, insert the Black wire into the PGND eyelet, entering from the solder side. Solder the wire on the component side.

6. Prepare a ***11" length*** of shielded cable per the directions that begin on Page 51. Prepare both ends per those directions. Twist and tin all four ends of the cable.
7. Working with one end of the shielded cable, insert the red wire into the IN eyelet, inserting it from the solder side, and soldering it on the component side.
8. Working from that same end, insert the drain wire into the INGND eyelet closest to the IN eyelet. Once again, insert it from the solder side, and solder it on the component side.
9. Cut an 11" length of 18 AWG stranded white wire. Remove 1/4" of insulation from both ends.
10. Insert the first end of the white wire into the OUT eyelet of the PCB, inserting it from the solder side, and soldering it on the component side.
11. Tin the remaining end of the white wire and insert it through the eyelet of a #10 lug. To be sure you have the #10 lug, the toothed portion should slide smoothly over the screws in the Red and Black speaker binding posts.
12. Crimp the white wire on the lug and solder it in place.

### ***Build the Ground Harnesses***

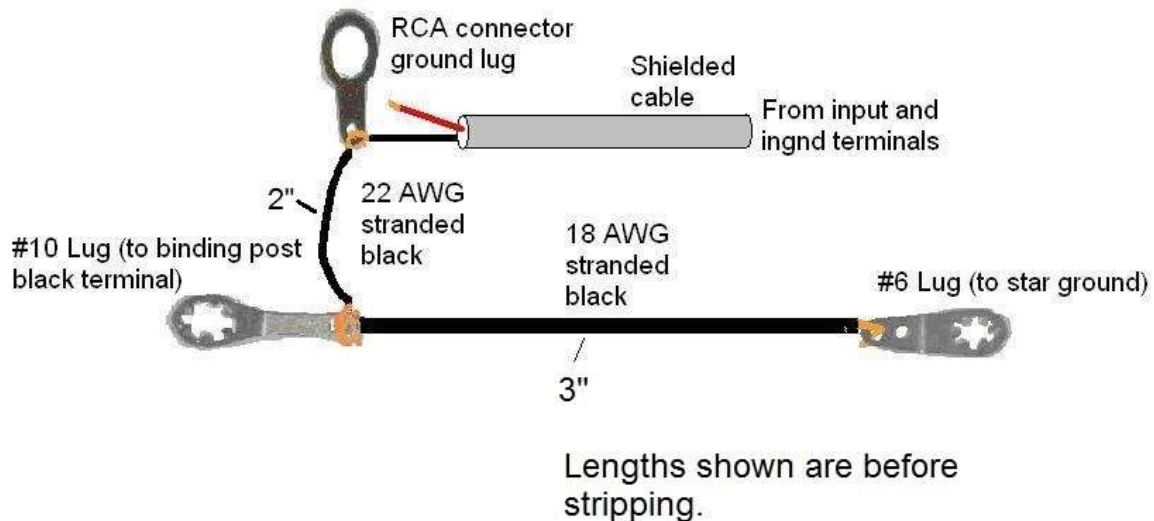
The left and right channel ground harnesses are the same. However, they have different lengths of shielded cable attached. Figure 24 shows the construction details. The wire lengths called out on the figure specify the before-stripping lengths of the wires.

Build two harnesses as shown:

1. Complete one harness using the left channel shielded cable.
2. Complete the second harness using the right channel shielded cable.

When this section is completed, you'll have both left and right channel amplifier modules with all the necessary wires connected, ready for installation in the chassis.

Unscrew the retaining nut from the RCA connectors to make the RCA connector ground lugs available for building the harnesses. Make sure to save the connector and nut.



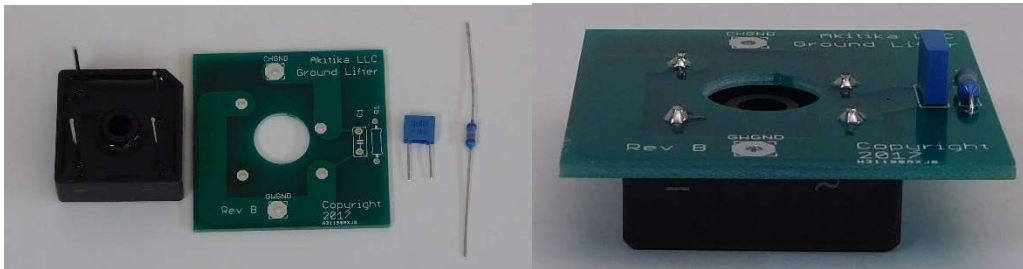
**Figure 24-Channel Grounding Harness**

You'll get the best results if you've tinned the stripped ends of the wires before you crimp them into the solder lugs. Once all the connections are crimped in place on a given lug, solder the lugs using enough heat to make the solder flow. When you do this, the wires should be straight, as the heat will encourage the insulation to back off a bent wire.

### **Build the Ground Lifter**

There's one more small circuit board to build, the ground lifter circuit board. It supplies a robust diode-bridged connection between the AC mains ground (often called Green Wire Ground or GWG) and the Chassis Ground where all the signal and power connections come together. The ground lifter helps reject ground loop noise that sometimes occurs when connecting components together. It's particularly effective in minimizing the ground wire noise that some computers generate.

Figure 25 shows the bare ground-lifter PCB, both before and after assembly. Note that the resistor and capacitor install from the silk-screen side of the board in the normal manner. In contrast, the bridge rectifier installs from the bottom of the board, and gets soldered on the silk-screen side.



**Figure 25-Ground Lifter PC Board**

Designation	Value	Marking	Done
R1	24.9	Red, Yellow, White, Gold, Brown	
C1	10 nF	10nJ100	
BR1		GBPC3506W	

1. Locate the green 18 AWG stranded wire with a FASTON terminal installed on one end. Cut it to an overall length of 14", measured from the far-end of the FASTON. Remove 1/4" of insulation from the plain end of the green wire. Insert it into the GWGND eyelet on the Ground Lifter PCB. Insert it from the side with the bridge rectifier, and solder it on the silk-screen side of the PCB.
2. Cut a 2" length of black 18 AWG stranded wire. Remove 1/4" of insulation from both ends. Insert one end into the CHGND eyelet on the ground lifter PCB. Insert it from the side with the bridge rectifier, and solder it on the silk-screen side of the PCB.
3. Twist and tin the other end of the wire. Insert it into a #6 lug. Crimp it and solder the wire to the lug.

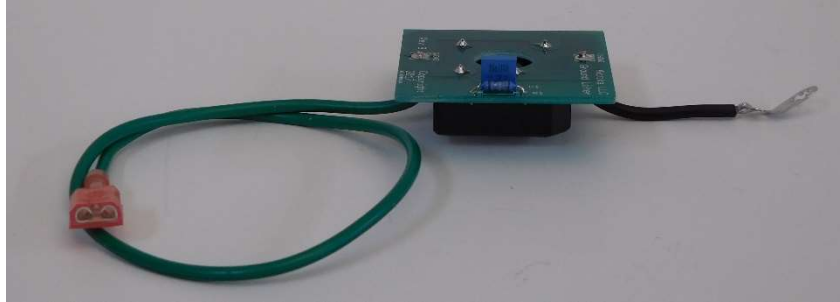


Figure 26-Ground Lifter PCB with ground wires connected

### ***Install the Feet***

Install the four feet into the corners of the bottom of the chassis using 6-32x 3/8" Phillips head screws (these are zinc-plated, so will look silver). Snug the screws, but don't over-tighten. Installing the screws will protect the bottom of the chassis from damage.

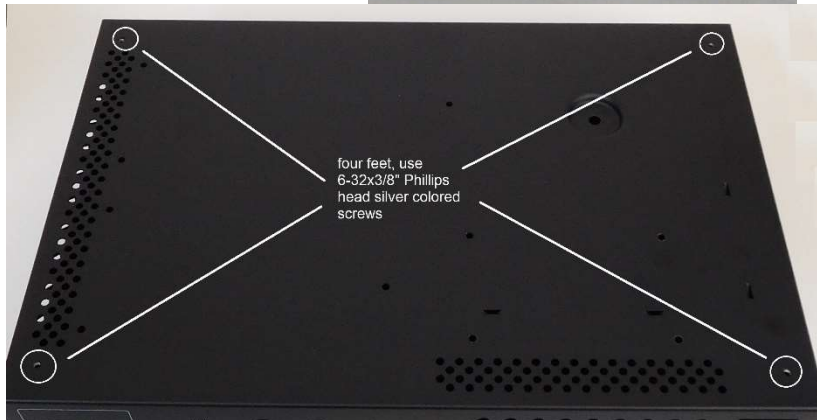


Figure 27-Install the feet here

### ***AC Power Wiring***

1. Locate the 1 foot long white and black 18 AWG wires with FASTONS on both ends. Twist the wires together. This minimizes the radiated hum fields.

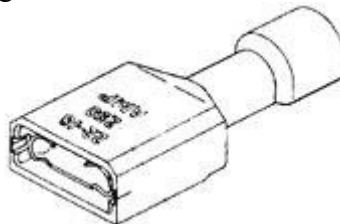


Figure 28-FASTON connector

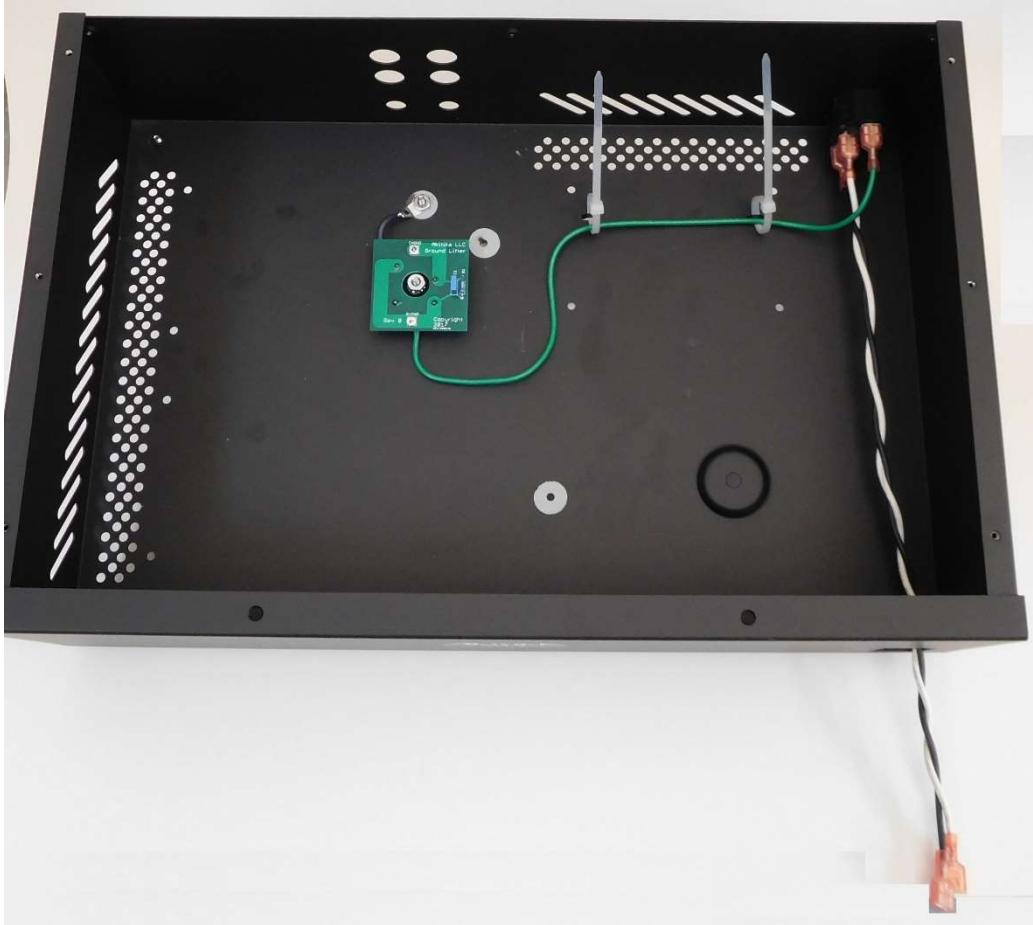
2. Slide the FASTON terminals onto the IEC power connector as shown in Figure 29.
  - i. Black wire to L (line) terminal.
  - ii. White wire to N (neutral) terminal.
  - iii. Don't connect the G $\perp$  (ground terminal) yet.

- iv. Green wire from the Ground Lifter board to the ground terminal  $\perp$



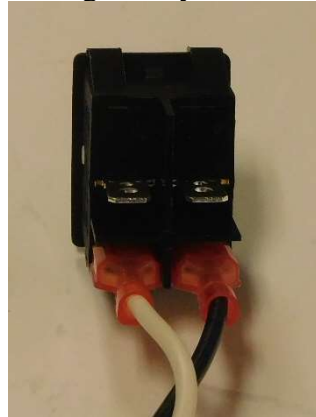
**Figure 29-Wiring IEC power connector line and neutral**

3. Starting outside the chassis, insert the black and white wires (already connected to the IEC power connector) into the hole in the back-right corner of the chassis as shown in Figure 30. **Make sure that the writing on the power connector is right side up!** Push until it clicks in place. It's easy to get it in, and tough to get it out, so double check the orientation before you install it.
4. Dress the black/white jacketed pair with FASTONs as shown in Figure 30. Insert the free end with the FASTONs through the rectangular switch hole in the front panel.
5. Connect the green wire from the ground lifter assembly to the ground terminal of the power entrance connector. It will be the top-most terminal, and the last open terminal on the connector.
6. Dress the green wire as shown in Figure 30 next to the tie down points. *Loosely loop cable ties as shown. We will tighten them later.*
7. Place the ground lifter assembly over the long threaded stud and secure it in place using a 6-32 keps nut (it has a built-in lock-washer). Tighten it snugly, but don't over-tighten.
8. Place the short black wire from the ground lifter assembly over the shorter threaded ground stud. Tighten down a plain #6-32 nut on the stud to hold the ground wire in place. Make sure it's secure.



**Figure 30-Power wiring with IEC connector installed into chassis**

9. Starting with the switch outside the chassis, push the FASTONS on the bottom switch terminals as indicated in Figure 31. The black or white wire may be on either side of the switch, so long as they both attach to the *bottom row* of contacts.



**Figure 31-Installing power wires on the switch**

10. *Leave the switch dangling outside the amp for now!!!*

## Installing Amplifier Modules into the Chassis

Be careful not to flex the chassis. It's a bit "squishy" with the top off, but becomes quite stout once the top is installed and screwed in place. You may want to place a towel on your work surface to avoid scratching the paint as you complete this section.

### Left Amplifier Module

1. Identify by wire lengths (or masking tape tags, if you made them) the left amplifier module (e.g. the amplifier that installs in the back of the chassis as viewed from the front).
2. This step can be a bit messy, and is considered optional. Completing this step assures the maximum transfer of heat into the chassis. You're also likely to smear white thermal compound on the inside of the amplifier as you set it into place. We'll leave the choice up to you (a little more available output power versus a little prettier insides of the amp). Spread a thin film of thermal compound on the 1/4" wide ridge of the heatsink (the side with two 6/32 mounting holes).

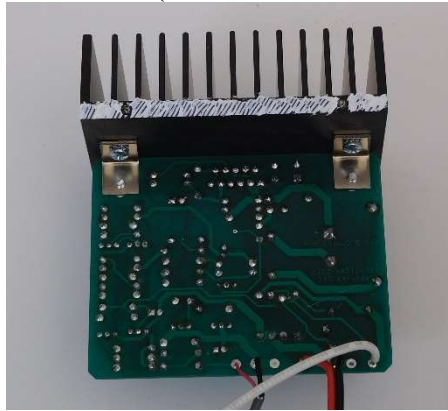


Figure 32-spread thermal compound on the 1/4" wide edge

3. Fit the left amplifier module in place and secure it in place using two black 6-32 3/8" screws inserted from the bottom of the chassis.

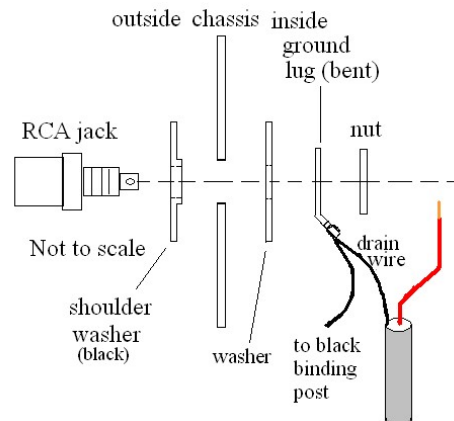


Figure 33-Installing RCA jacks

4. Insert the RCA jack and the *two insulating washers* and ground lug as shown in Figure 33. The ground lug already has two black wires attached. Tighten the mounting nut. Note that there are shoulders on the insulating washer that keep the RCA connector's body from touching the chassis.



5. Solder the (pre-tinned) red wire of the shielded cable to the center terminal of the RCA jack.

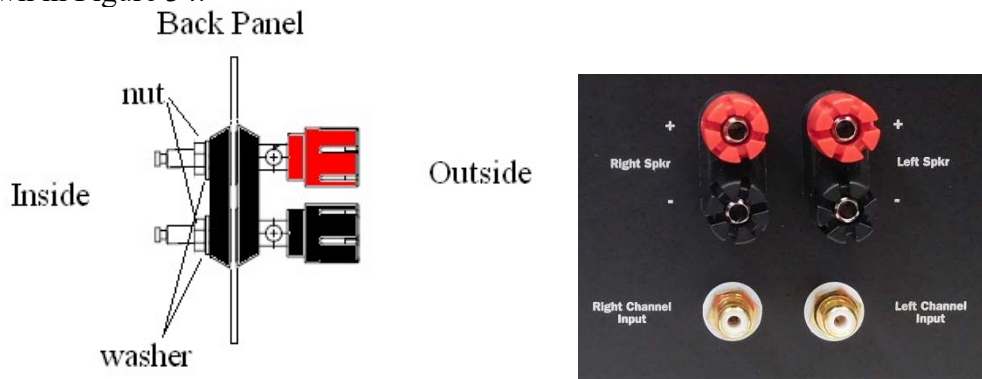
### Right Amplifier Module

1. Identify by wire lengths (or masking tape tags, if you made them) the right amplifier module (e.g. the amplifier that installs in the front of the chassis as viewed from the front).
2. This step can be a bit messy, and is considered optional. Completing this step assures the maximum transfer of heat into the chassis. You're also likely to smear white thermal compound on the inside of the amplifier as you set it into place. We'll leave the choice up to you (a little more available output power versus a little prettier insides of the amp). Spread a thin film of thermal compound on the 1/4" wide ridge of the heatsink (the side with two 6/32 mounting holes).
3. Fit the right amplifier module in place and secure it in place using two black 6-32 3/8" screws inserted from the bottom of the chassis.
4. Insert the RCA jack and the *two insulating washers* and ground lug as show in Figure 35. The ground lug already has two black wires attached. Tighten the mounting nut. Note that there are shoulders on the insulating wire that keep the RCA connector's body from touching the chassis.
5. Solder the (pre-tinned) red wire of the shielded cable to the center terminal of the RCA jack.

### ***Install the Speaker Binding Posts***

The two speaker output connectors are heavy duty 5-way binding posts. Remove both nuts and the washer from each binding post. Install them into the chassis as shown in Figure 34. Make sure that the Red binding post is on the top. You'll use only one nut and washer to retain each binding post for now. Return the other nuts to the soup-bowl for safe-keeping. They will be used in a later step, when they are re-installed to fasten a solder lug to the terminal.

The black plastic insulators have shoulders that fit inside the mounting holes. Make sure that the shoulders are centered in the mounting holes. They keep the binding post studs from shorting to the chassis. The binding post wire-insertion holes should be horizontal, as shown in Figure 34.



**Figure 34-Install both left and right binding posts**

## **Connect the Speaker Binding Posts**

### Left Amplifier Module

1. Slip the #10 lug from the left channel ground harness (black 18 AWG wire) over the black binding post stud. Position the lug as shown in Figure 35, then use a binding post nut (5/16" nut driver) from the soup bowl to hold the lug in place.
2. Place the #6 lug at the other side of the ground harness over the short ground stud on the chassis floor.
3. Slip the #10 lug from the white #18 AWG white wire that connects to the left amplifier module OUT terminal onto the RED speaker binding post stud. Position the lug as shown in Figure 35, then use a binding post (5/16" nut driver) nut from the soup bowl to hold the lug in place.

### Right Amplifier Module

1. Slip the #10 lug from the right channel ground harness (black 18 AWG wire) over the black binding post stud. Position the lug as shown in Figure 35, then use a binding post nut (5/16" nut driver) from the soup bowl to hold the lug in place.
2. Place the #6 lug at the other side of the ground harness over the short ground stud on the chassis floor. Don't install a nut yet.
3. Slip the #10 lug from the white #18 AWG white wire that connects to the right amplifier module OUT terminal onto the RED speaker binding post stud. Position the lug as shown in Figure 35, then use a binding post (5/16" nut driver) nut from the soup bowl to hold the lug in place.

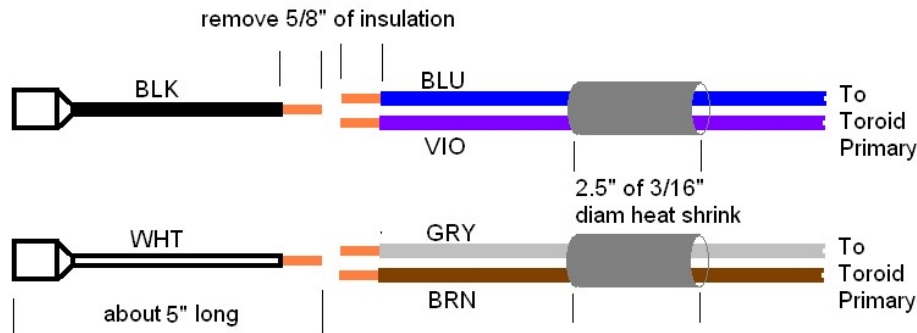


**Figure 35-I/O Connector wiring**

## Transformer Preparation

The directions in this section cover 120 Volt wiring. For 240 Volt wiring, you'll need the V240 kit. This kit has the parts and directions to wire the transformer for 240-volt power. The kit builder must supply a country-specific 240 Volt power cord.

Locate the 5" long black and white 18 AWG wires with FASTON connectors pre-installed on one end. Also locate the 3/16" diameter (clear) heat shrink tubing. For 120 Volt<sup>4</sup> wiring, the FASTON and toroidal primary wires will be connected as shown in Figure 36.

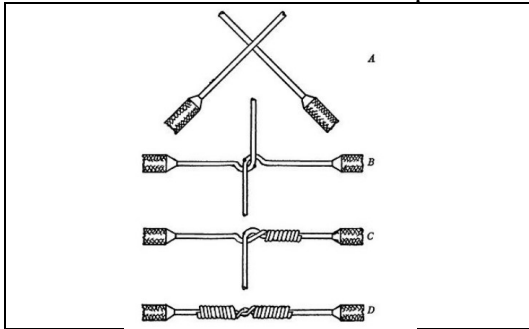


**Figure 36-Wiring toroidal transformer for 120 Volt operation**

1. Cut a 2.5" length of 3/16" diameter heat-shrink tubing. Slide it over the blue and violet leads of the power transformer. Slide it as far from the cut ends of the wire as possible.
2. Cut a second 2.5" length of 3/16" diameter heat-shrink tubing. Slide it over the gray and brown leads of the power transformer. Slide it as far from the cut ends of the wire as possible.
3. Cut 1/4" off the tips of the blue, violet, gray and brown transformer wires. This removes the portion of the wire that has solder from the manufacturing process. Doing so allows you to make a smooth Western Union splice, shown below.
4. Remove 5/8" of insulation from the following 6 wires:
  - i. Black 4" FASTON wire
  - ii. White 4" FASTON wire
  - iii. Blue Transformer wire
  - iv. Violet Transformer wire
  - v. Gray Transformer wire
  - vi. Brown Transformer wire
5. Twist together the stripped ends of the brown and gray transformer wires
6. Twist together the stripped ends of the blue and violet transformer wires.
7. Make a Western Union splice between the brown-gray and the 4" white FASTON wire.
  - i. Solder the splice.
  - ii. Slide the heat shrink tubing evenly over the splice
  - iii. Use the tip or the barrel of the iron to shrink the heat shrink tubing.
8. Make a Western Union splice between the blue-violet and the 4" black FASTON wire.
  - i. Solder the splice.

<sup>4</sup> For 240 Volt wiring, see the directions that come with the V240 kit.

- ii. Slide the heat shrink tubing evenly over the splice
- iii. Use the tip or barrel of the iron to shrink the heat shrink tubing.



*Important Note:*

- Check your Western Union splices for smoothness. Sharp wire points must not push into the heat shrink tubing.
- If you even suspect that to be the case, then you must wrap each piece of heat shrink tubing individually with a layer of electrical tape.

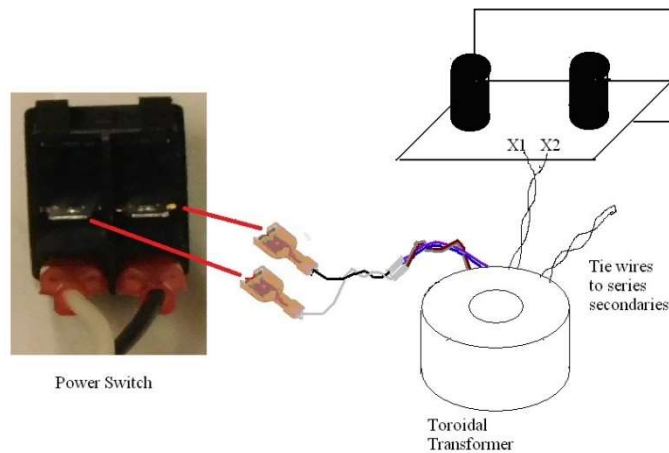
**Figure 37-Western Union splice has diameter less than the insulated wires and no sharp points**

9. Cut the red and orange transformer wires to a length of about 2”.
10. Remove 3/8” of insulation from the red and orange transformer wires.
11. Twist the insulated parts of the orange and red wires together. Now twist the bare ends together and solder them to each other. Slide a 2” piece of 1/8” diameter (black)<sup>5</sup> heat shrink tubing over the pair of wires, about half on, and half off.
12. Use the tip or the barrel of the soldering iron to shrink the heat-shrink tubing all along its length.
13. Once the heat-shrink tubing has cooled, test your work by tugging on the heat shrink to assure that it will remain in place.
14. Cut the black and yellow transformer wires to a length of 3.5”. Twist together the insulated portion of the black and yellow transformer wires. Twisting the pair reduces hum.
15. Strip 3/8” of insulation from the black and yellow wires of the transformer. Twist and tin each wire, preparing them for installation into the power supply in a later step.

## Transformer Installation

1. Set the transformer into the chassis, wire side up, over the raised circle in the chassis floor. You won’t bolt it into the chassis until after the shield has been installed.
2. Twist the transformer primary leads (that’s the transformer wires with the FASTON connectors) together to form a twisted pair. Slide the FASTON connectors from the toroidal power transformer thru the switch cut-out in the front panel. Connect them to the indicated switch terminals. Place black over black and white over white.

<sup>5</sup> The transformer in some kits has thicker insulation for the orange and red wires. In that case, the black 1/8” heat-shrink won’t easily fit over the wires. Instead, use a 2” piece of the white 3/16” heat-shrink.

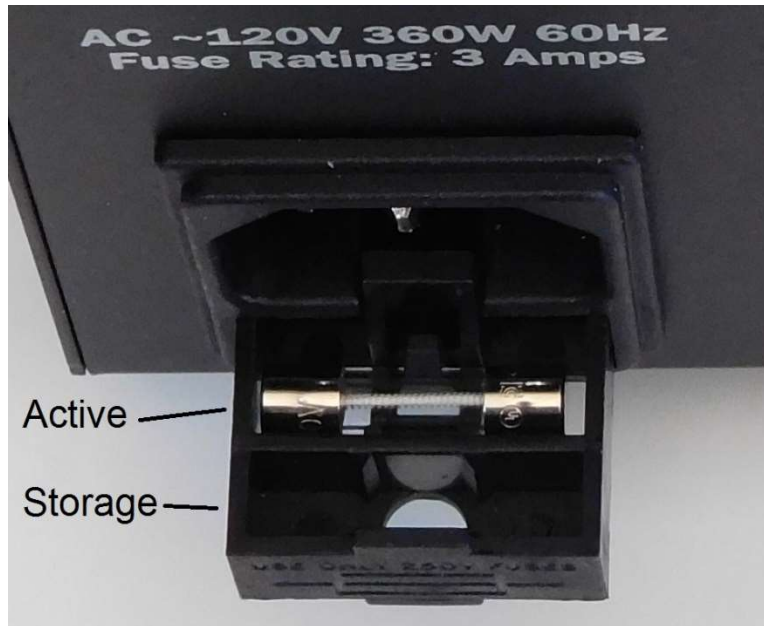


**Figure 38—connecting up the power transformer**

3. Insert the switch in from the front of the chassis. It may be a snug fit. **Make sure that the is at the top of the opening** before you insert the rocker switch into the chassis. Push the rocker switch in the rectangular opening; it will click into place.
4. Dress the black-white twisted pair that goes from the switch to the power entrance connector into the crease along the right side of the chassis.
5. Dress the transformer primary leads as shown on the front cover of this manual.
6. Lay the power supply assembly into the case, fin side down, centered along the back of the chassis. The solder side of the circuit board should face the front of the chassis.
7. Insert the black and yellow transformer wires into the X1 and X2 terminals of the power supply PCB, inserting them from the solder side and soldering them on the component side. Connect black to X1 and yellow to X2, but it doesn't matter if they are reversed.

### ***Testing the Power Supply***

1. Make sure that green ground wire from the IEC power entrance connector in the back-right corner of the chassis connects to the GWGND eyelet of the ground lifter PCB. Make sure that the wire from the CHGND eyelet of the ground lifter PCB connects to the grounding stud located between it and the back wall of the chassis, and that is secured by a tightened 6-32 nut.
2. Make sure that the power supply module PCB does not touch the chassis at any point.
3. Open the fuse drawer in the IEC power connector and make sure that the fuse is installed in the active slot of the drawer. It was placed there when the kit was packed to keep the glass fuse cartridge safe during transport. Close the fuse drawer. The fuse and fuse drawer is retained by the force of the contacts. If the fuse drawer flops open, you probably have placed the fuse in the spare location, as opposed to the active location.



**Figure 39-Showing active and storage locations in the fuse drawer**

4. Make sure that the power switch is in the off position (the bottom part of the rocker switch, labeled with a 0, is flush with the front panel).
5. Locate the supplied IEC power cord. Make sure it is NOT connected to the AC wall socket yet. Connect one end to the IEC power connector on the chassis.
6. Standing well away from the amplifier, connect the plug into the AC wall socket. Keeping one hand in your pocket, use the other hand to turn on the power switch.
7. The power switch should light up, but very little else observable should happen.
8. Observe the power supply, transformer, and wiring for any signs of heating or distress.
9. If everything seems cool (please pardon the pun), the probe the VCC and PGND eyelets on the power supply PCB with a DC volt meter. The voltage should be 56 volts (+/- 4 Volts) DC.
10. If the previous test is correct, then:
  - a. Turn off the power switch
  - b. **Pull the power cord from the wall socket**
  - c. **Remove the power cord from the power entrance connector on the chassis**
  - d. Go away from the amp for five minutes to celebrate and let the output capacitors discharge.

The raw power supply has only light bleeder resistors. It may take 5 minutes for the main filter capacitors to discharge.

## ***Final Amplifier Wiring***

In this section, you'll wire the amplifier modules to the power supply. A quick look at the cover illustration will clarify anything not made clear by the following instructions.

## Wiring Amplifier Power

1. Identify the red/black zip cord that connects to the left amplifier module VCC and PGND pins. Route them along the chassis floor and toward the VCC and PGND pins of the power supply.
  - a. Insert the red wire into the VCC pin closest to the large capacitor, C6, from the solder side of the PCB and solder it on the component side. Don't let your soldering iron slide into C6.
  - b. Insert the black wire into the PGND pin closest to the large capacitor, C6, from the solder side of the PCB and solder it on the component side. Don't let your soldering iron slide into C6.
2. Identify the red/black zip cord that connects to the right amplifier module VCC and PGND pins. Route them along the chassis floor and toward the VCC and PGND pins of the power supply.
  - a. Insert the red wire into the remaining VCC pin from the solder side of the PCB and solder it on the component side.
  - b. Insert the black wire into the remaining PGND from the solder side of the PCB and solder it on the component side.

## Fasten the Power Supply to the Chassis

1. Tighten the cable ties that hold the green ground wire in place. Make sure that as positioned, it will not interfere with mounting the power supply heat sink. Cut the long tails of the cable ties.
2. This step is optional, but it is recommended if you listen for long periods at high levels. Spread a thin film of thermal compound on the 3/8" wide ridge of the heatsink (the side with two 6/32 mounting holes).

*Note: the transformer is not yet fastened in place. Leave the chassis flat to avoid a "gravitational accident" where the transformer goes rolling or sliding and leads rip loose.*

3. Place the power supply module onto the chassis and secure it in place using two black 6-32x3/8" pan-head Phillips screws inserted from the bottom of the chassis. I like to do this by sliding the edge of the chassis over the edge of the table, and inserting the screws from underneath the chassis.
4. Ground Stud
  - a. The ground stud already has a #6 lug, the black wire from the ground lifter PCB, and a #6-32 nut holding the lug in place. Make sure the nut is tight.
  - b. Above that nut, place these three #6 ground lugs:
    - i. From the ground eyelet of the power supply PCB
    - ii. From the ground (black) binding post of the left amplifier.
    - iii. From the ground (black) binding post of the right amplifier.
  - c. Place another #6-32 nut on top of the lugs, and tighten the nut to secure the grounding lugs in place.

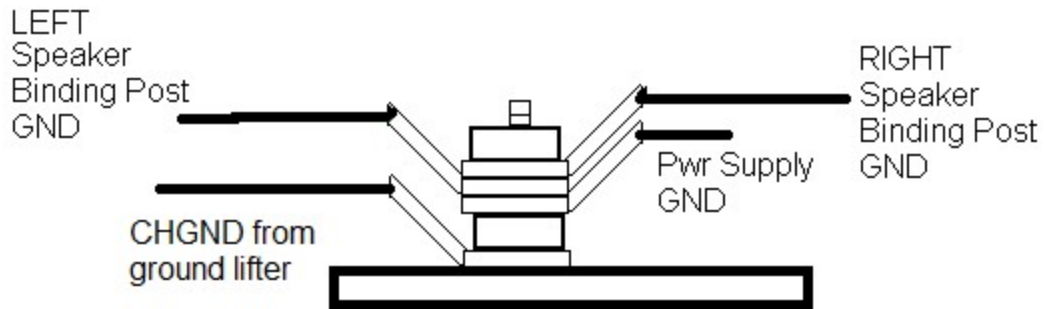


Figure 40-Grounding Stud Detail

### Install the Wall and Fasten the Transformer Down

If you've been following along, the transformer is not yet fastened in place. This will allow you to slide it toward the right chassis wall, making room to insert the divider-wall into the chassis. You may even decide to temporarily stand the transformer on its side to make extra room for this operation, but it really isn't necessary. Check the front cover to see which way the wall goes.

This is admittedly a bit of a Rubik's cube operation, but if you slide the front end of the wall right and the back end left, and get the wall under the front lip, it will fall into place.

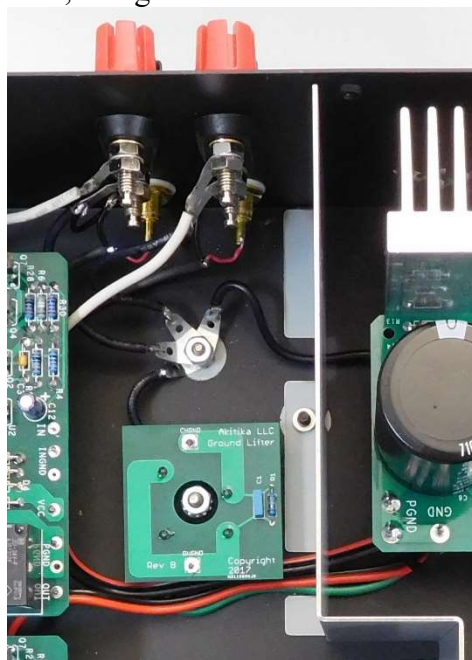


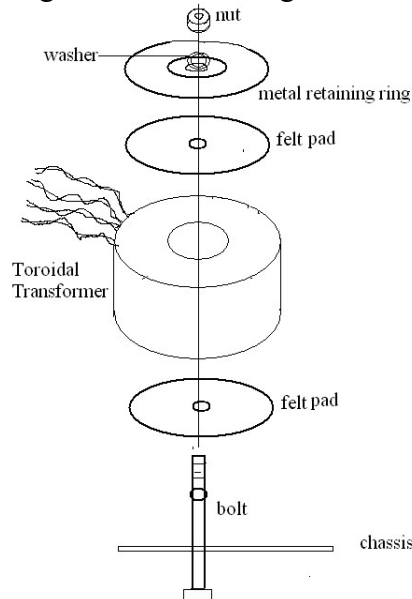
Figure 41-Routing the wires through the slots in the wall

Refer to Figure 41 to see how the power and ground wires route through the slots in the wall:

1. Route the power supply ground wire through the back hole in the wall.
2. Route both red/black power leads from the power supply and the Green Wire Ground lead from the power entrance connector through the front hole in the wall.
3. Make sure neither will be pinched when the wall is tightened in place. But first, we'll complete installation of the toroidal transformer.



4. Mount the toroidal transformer to the chassis using the hardware shown in Figure 42. Orient the toroid and power wiring as shown on the front cover of this manual. Make sure the mounting hardware and toroid are centered before tightening the mounting bolt. Make it snug, but do not over-tighten.



**Figure 42-Toroidal Transformer Mounting**

5. Fasten the wall to the bottom of the chassis using two 6-32x3/8" black screws installed from the bottom of the chassis and into the fasteners on the wall. Make sure that the wires pass easily through the slots in the wall, and aren't being pinched.

You have now completed all the wiring and 99% of the assembly of the amplifier.

## Visual Inspection

Check for the following items:

1. Power Supply wiring from the power supply to both amplifier modules is in place.
2. ***Double check the polarity of the power supply wiring!***

## Section 5: Testing It Out and Installing the Top

*Be careful. The amplifier will be energized with the top off, and hazardous voltages will be present in the amplifier. Use appropriate precautions to avoid injury.*

Once the visual inspection looks ok and any shortcomings have been corrected, you can perform the following tests.

### Power-Off Tests

1. Connect an ohm-meter to the left channel red and black binding posts. The resistance should read between 900 and 1100 Ohms. The nominal value is 1000 Ohms.

2. Connect an ohm-meter to the right channel red and black binding posts. The resistance should read between 900 and 1100 Ohms. The nominal value is 1000 Ohms.
3. Disconnect the ohm-meter, and set it to DC volts, in preparation for the next tests.

### **Power-On Tests**

The only connections for these tests will be the AC mains power and/or the DC meter used to measure voltages. Make sure to keep clear of the high voltage. Plug in the amplifier and turn on the power. Watch it closely for one minute as you check for the lack of smoke. Turn the amplifier off quickly if you see any smoke!

Most typically:

1. The green LED's (one on each amplifier board) should light up.
2. After about 7-10 seconds, you should hear the click of the speaker relays. If this is successful, then perform the following additional steps.

Measure the following DC voltages, repeating the test for both the left and right channel outputs.

1. Measure the DC voltage between the red and black speaker binding posts (with no speaker connected). You may see as much as 1 volt, which represents 1 mA of leakage current in the large output capacitor flowing through the 1K bleeder resistor on the output. The voltage will typically decline with time. When a speaker is present, the DC voltage will be less than 10 millivolts.
2. Turn the power off.

### **Install the Top and the Z4 Label**

Slide the top in place. Install the 11 #4-40x1/4" black flat-head Phillips head screws that keep the top in place.

Install the Z4 label in the center of the front panel as shown here:



## **Section 6: Using the GT-102**

1. Connect an input source to the RCA input jacks with the preamp volume down.
2. Connect a pair of speakers to the amplifier.

3. Turn the power on. There will be a roughly 7-10 second delay during which the amp powers up during which the amplifier's operating point stabilizes. The end of the delay time is marked by the soft click of the speaker relays (they will be slightly staggered in time).
4. Please note that with inputs disconnected, the speakers should be quite quiet.

When using the GT-102:

- Don't block the ventilation holes on the sides or the top of the amplifier.
- The amplifier has speaker relays that keep the speaker completely disconnected from the amplifiers until about 7-10 seconds after power up.
- Protection circuits will shut the amplifier down in case of overload or abuse. If this happens:
  - Turn off the power
  - Remove the overload condition
  - Turn down the input level
  - Turn on the amplifier, and in 7-10 seconds, you're ready to listen again.
- The amplifier is so quiet that with no input source connected, or with the input shorted, you will hear almost nothing from your speakers.
- The amplifier may have a tiny pop/thump at turn-off, determined by where in the cycle the musical signal was before the relay opened. This is normal.

## Section 7: Specifications and Schematics

Output Power (measured at 1 kHz):

- greater than 50 Watts per channel into 4 Ohms
- more than 65 Watts per channel into 4 Ohms at 1% distortion (typical)

Small Signal Bandwidth: wider than 5 Hz to 50 kHz at -3 dB points

Damping Factor @ 1 kHz wrt 4 Ohms > 40

Signal to Noise Ratio: nearly 133 dB below 50 Watts into 4 Ohms, referred to a shorted input, A weighted

Harmonic Distortion: typically 0.006% at 60 Watts into 4 Ohms at 1 kHz. Clipping occurs at a bit more than 68 Watts into 4 Ohms at 1 kHz.

Intermodulation Distortion (typ): 0.004%, SMPTE 60 Hz, 7 kHz, 4:1

Separation: more than 80 dB for any frequency below 20 kHz.

Input Impedance: 51 K Ohms

Sensitivity: 0.777 Volt RMS input produces 16 Volts RMS output (equivalent to 64 Watts into 4 Ohms)

Input Power: IEC connector (North America style power cord supplied)

Input Power Fuse Rating and type:

- 120 Volt Operation - 3 Amp Slow Blow, 5x20 mm
- 240 Volt Operation - 1.5 Amps Slow Blow, 5x20 mm

Idle Power Drain (120 Volt Operation) - 17.5 Watts

Operating Temperature Range: 0 to 40 C Ambient

Dimensions: 15" Wide x 10" Deep x 4.5" Height (includes height of the feet)

Weight: 15.5 lbs

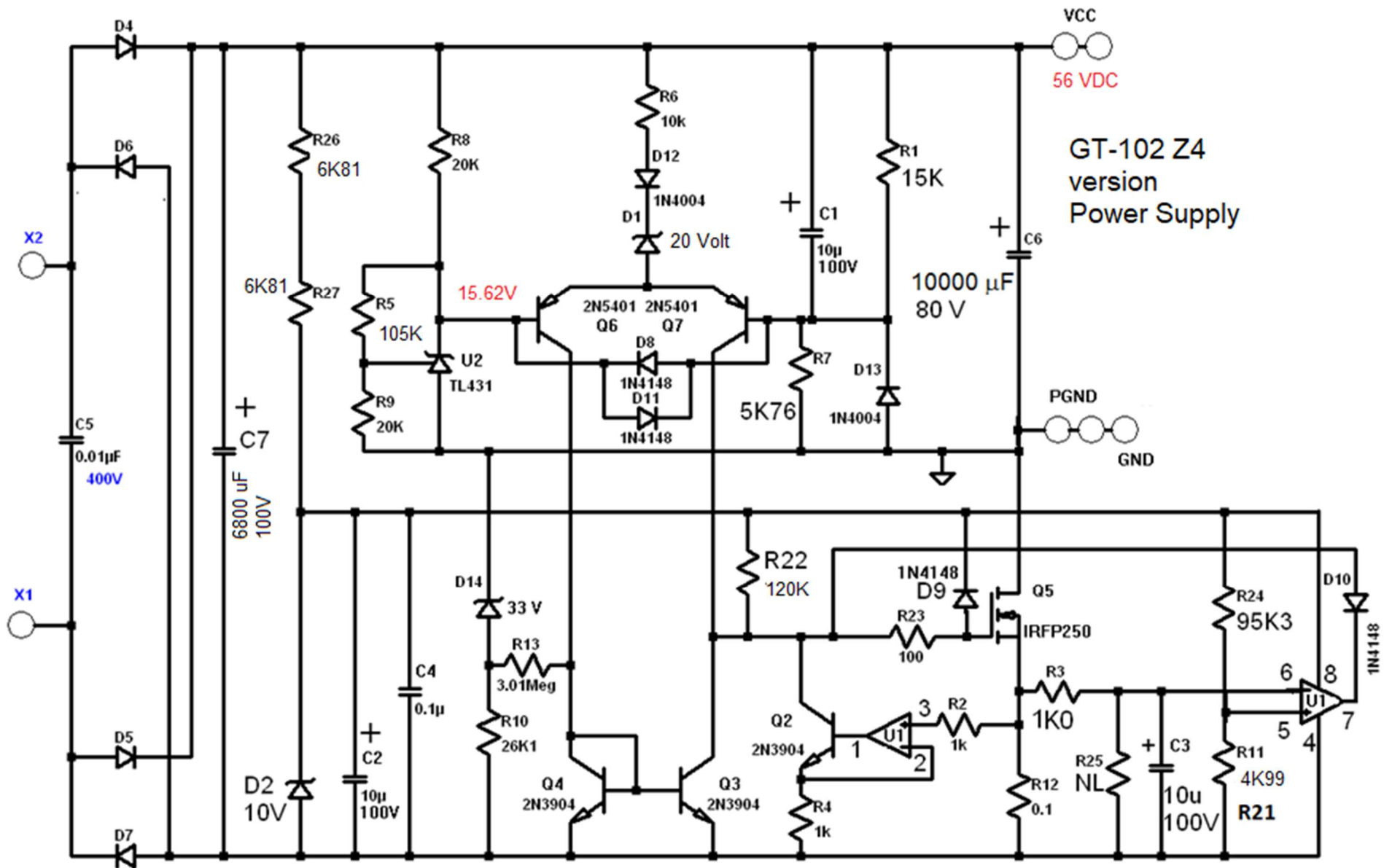


Figure 43-Power Supply Schematic

Z4 Version of  
 GT-102 Amplifier Module  
 Copyright 2017-2019  
 All Rights Reserved  
 U1 is LM3886 with  
 non-isolated case

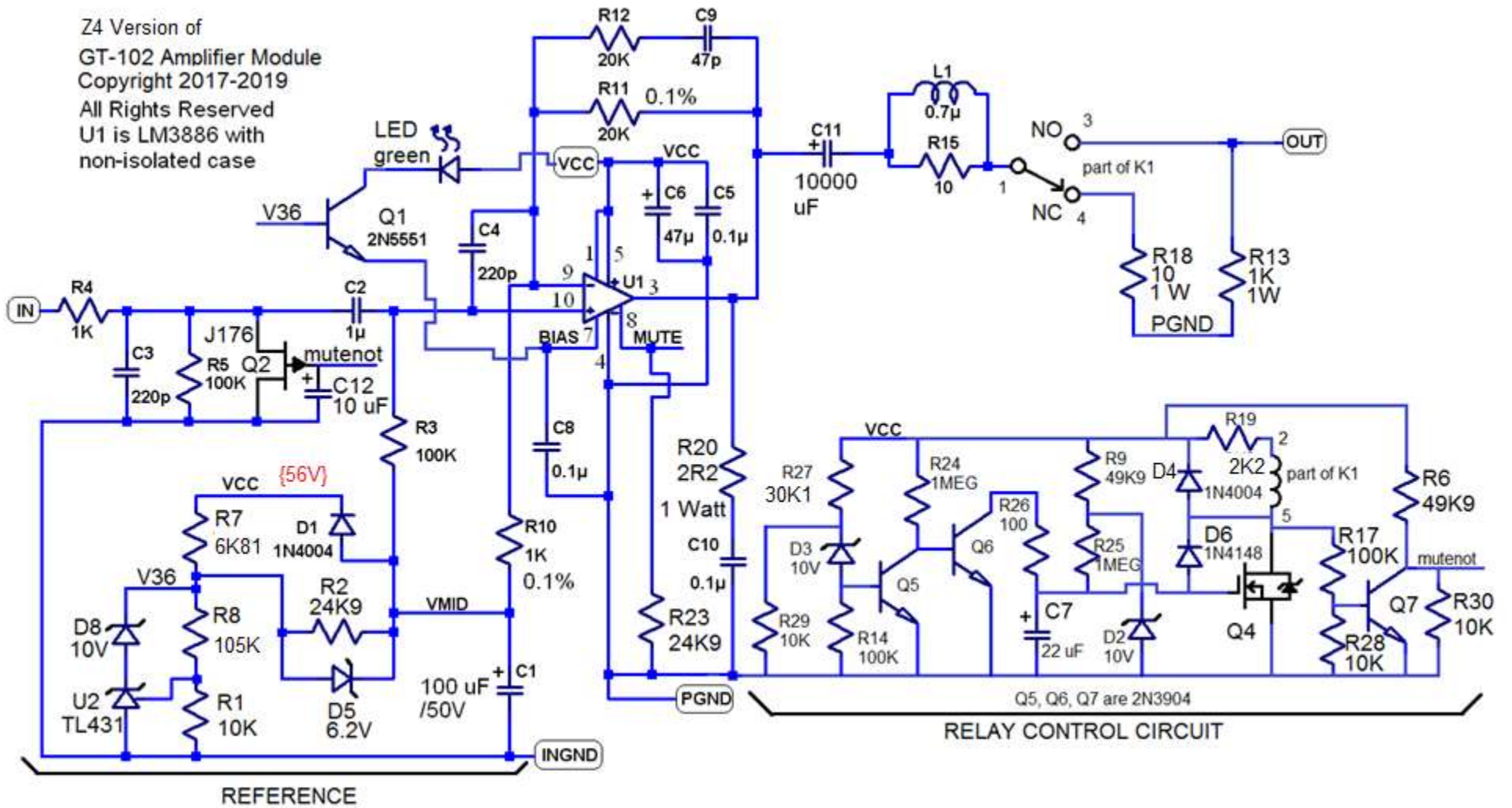


Figure 44-Amplifier Module Schematic

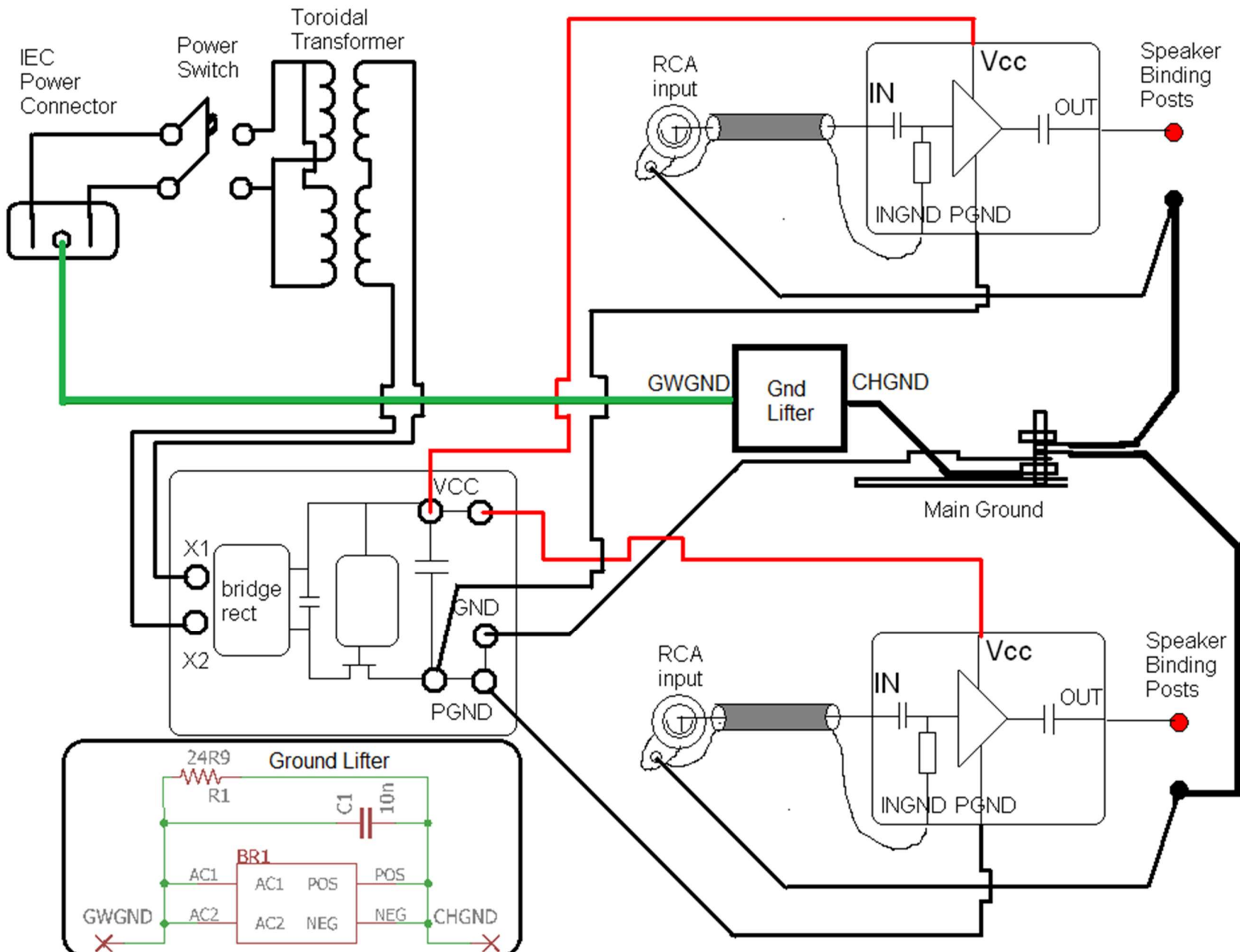


Figure 45-Overall Wiring (power transformer is wired for 120 VAC)

## Section 8: Theory of Operation

### ***Power Supply***

The following discussion refers to Figure 43.

### **Bulk DC Supply**

We begin at the left side of the schematic. The toroidal power transformer steps the 120V or 240 V AC mains (selected as a wiring) option to about 53 Volts RMS<sup>6</sup>. D4-D7 form a bridge rectifier that changes the input voltage to pulsating DC. C7 smooths that voltage. When lightly loaded (e.g. with the amps at idle or disconnected), there will be about  $74.2 * 1.414 - 1 = 76$  Volts DC across C7. C5 keeps switching noise from the diode bridge confined onto the power supply PCB, preventing it from radiating.

The rest of the circuit regulates the pulsating DC voltage across C7, turning it into a low-noise source of well-regulated 56 Volts DC that powers the amplifier modules. We'll now go over the operation of the regulator.

### **Pass Transistor**

Understanding this topology may make your head hurt. We will try to minimize the pain. Q5 is the pass transistor. Control circuits modulate its conductivity to stabilize the output voltage. The tricky thing? Q5 is in the negative rail. It would be much easier to think about if it were in the positive rail, but then we wouldn't be able to directly connect the drain to a grounded heatsink. That direct connection makes for the most effective heatsinking.

### **Regulator Control Circuits and their Power Supply**

R26, R27, and D2 set up a 10 Volt supply that runs the regulator control circuits. C2 and C4 provide power supply bypassing for the regulator control circuits. R8, R5, R9, and U2 set up a 15.62-volt reference voltage on the base of Q6. Q6 and Q7 work together to make an error amplifier. The output voltage is sampled by R1 and R7. They provide a voltage on Q7 that is compared against the 15.62-volt reference. Differences between the base of Q6 and Q7 produce a drive signal that changes the conductance of Q5 to stabilize the output voltage. D7 and D11 limit the drive at the bases of the error amplifier, protecting Q6 and Q7 during turn-on and turn-off.

Q3 and Q4 form a current mirror that makes use of the collector currents of both Q6 and Q7 to drive Q5. This maximizes the gain of the error amplifier, improving regulation and accuracy of the output voltage.

### **Current Limiting**

The components not discussed to this point are used during start-up or for protection. U1 (pins 5, 6, and 7) limits the maximum DC (continuous) current that the power supply can

---

<sup>6</sup> The actual voltage, when lightly loaded, is about 6% higher, or 74.2 Volts RMS.

deliver. R24 and R11 form a voltage divider that applies 0.5 volts to the positive input of U1. The negative input of U1 (pin 6) is driven by a low pass filter that senses the power supply output current. The DC current limit is set by  $0.5 \text{ V}/0.1 \text{ Ohms}$  (R12) at 5 Amps. Thus the power supply can deliver  $5 \times 56 = 280$  watts continuously. It delivers more than that for short periods of time, as determined by the R3-C3 time constant, and aided by the large size of C6, the 10,000  $\mu\text{F}$  output filter capacitor. When the DC current exceeds 5 Amps, pin 7 of U1 goes low, robbing gate drive from Q5 by way of D10. This protects both the power supply and the amplifier in the event of fault conditions.

### **Start-up Circuits**

The power supply starts up in a constant current mode, delivering about 0.42 Amps. This can be calculated by  $7/R22 \times R4/R12$ . Q2 and U1 create a collector current in Q2 that is  $1/10000$  ( $R12/R4$ ) of the output current. That current balances the current flowing in R22, driving the gate of Q5 to a level that makes about 0.42 Amps of current in pass transistor Q5.

The power supply remains in constant current mode, supplying the amplifier modules and charging C6. This slows the rise of the output voltage. When the output voltage is more than about 37 volts, D12 and D1 are forward biased. That turns on the Q6-Q7 error amplifier, which changes the power supply from constant current to constant voltage operation. From 37 volts to 56 volts, the output would rise quickly were it not for the effect of C1, which continues to give the output voltage a slowed rise-time. This limits the charging current in C6. Without a limit on the rise time, the charging current for C6 might be large enough to cause troubles.

D14, R10, and R13 limit the current that the power supply delivers in start-up mode. When there's more than 33 volts across the pass transistor (at startup, there's almost 76 volts across the pass transistor), we limit the current. With 0 volts across C6, there are about 43 volts across R13, 3 Megohms, which diminishes the current from R22 by 14  $\mu\text{A}$ . That leaves  $7/120000 - 14 \mu\text{A} = 44 \mu\text{A}$  of drive current for Q5. Multiplied by the gain of 10000, given by  $R4/R12$ , that gives 440 mA available for startup.

R23, 100 Ohms, is used to stop high frequency oscillation in Q5. D9 prevents more than 10.7 volts from being applied to the gate of Q5, protecting it from damage.

### **Amplifier Modules**

This discussion refers to Figure 44.

The amplifier modules are based around the LM3886 power amplifier, U1.

R4 and C3 make a low-pass filter to eliminate radio stations that otherwise might be picked up on the inputs. R5 establishes a steady bias voltage across coupling capacitors in the output of the driving preamp and C2 as well. C2, a film capacitor, couples the input signal to pin 10 of U1. Q2 mutes the input to the amplifier until the power supply has reached operating voltage.



## Reference Voltage Generator

R1, R7, R8, D8, and U2 establish a 28.75-volt reference at node V36. D8 assures that 18.75 volts appears across U2, keeping it well within its 36-volt rating. R2 isolates V36. D5 helps charge C1 more quickly during turn-on, establishing the output voltage relatively quickly. V36 also sets the output voltage of the amplifier at 36 volts, half the supply rail. This is the optimum point to allow maximum linear output swing.

Q1 sets the required  $\frac{1}{2}$  supply bias voltage on pin 7, the bias pin. The LED lights up as there's about 10 mA flowing in the bias pin, plus some signal dependent current.

## Gain Setting Circuits

R11 and R10, 0.1% tolerance resistors, set the amplifier's gain so accurately that the amplifiers can be easily paralleled by paralleling the input pins and paralleling the output binding post. C4, C9, and R12 help keep the amplifier stable under all conditions. C1 sets the low frequency -3 dB point at 1.59 Hz. This keeps the signal across C1 in the audio band miniscule, assuring high linearity. The input -3 dB point is dominated by C2 and R3, at about 1.59 Hz.

R23 pulls a bit more than 1 mA out of the mute pin, assuring that the amp is not muted. C11, the output coupling capacitor, couples the amplifier's output to your speakers. L1, wound around C11, and R15 isolate capacitance in the speaker, also assuring stability for all load types. C11, at 10,000  $\mu$ F, makes a -3 dB point of 2 Hz when driving an 8 Ohm speaker (4 Hz when driving a 4 Ohm speaker).

## Relay Control Circuit

K1 mutes the output of the amplifier during power up and power down. That avoids any pops or clicks during those times. R18 charges up C11 during the turn-on period. R13 keeps C11 discharged in the absence of a speaker load.

The relay control circuit keeps the relay open and the input muted until the power supply reaches about 43.4 volts. R27, R29, and D3 set this voltage. R24 and Q6 keep C1 discharged until the power supply exceeds 43.4 volts. After that, relay opening is further delayed by the charging time of C1 through R25. D2 sets a 10-volt bias voltage at the top of R25, making for a repeated turn-on delay.

D6 limits the gate voltage on Q4, which protects Q4, and provides consistent operation of the delay function. Q6 resets C1, the delay capacitor, when the power supply voltage drops below 43.4 volts. R26 limits C1's discharge current.

R17, R28, R6, R30, and Q7 control J176, a P-channel JFET that mutes the input whenever the power supply is less than 43.4 volts. C12 delays the muting function and allows it to smoothly be removed, making for a smooth transition from silence to sound.

## Appendix 1 - Resistor Color Code



**Figure 46-demonstrating the resistor color code**

Here's an extreme close-up of a  $\frac{1}{4}$  W metal film 20K (20,000) Ohm resistor, designated by the standard resistor color code.

The colors map to numbers:

Color	Number
Black	0
Brown	1
Red	2
Orange	3
Yellow	4
Green	5
Blue	6
Violet	7
Gray	8
White	9

The color band positions have the following meaning:

Position	Meaning
1	Left-most Digit (e.g. most significant)
2	Next digit to the right
3	Next digit to the right.
4	Number of zeros that follow the three digits, unless: <ul style="list-style-type: none"> <li>• Band 4 is gold =&gt; multiply by 0.1</li> <li>• Band 4 is silver=&gt; multiply by 0.01</li> </ul>
5	Tolerance: <ul style="list-style-type: none"> <li>• Violet =&gt; 0.1%</li> <li>• Brown =&gt;1%</li> <li>• Red =&gt; 2%</li> <li>• Gold=&gt; 5%</li> <li>• Silver=&gt;10%</li> </ul>

## Appendix 2 - Preparing a Shielded Cable End

This section tells how to prepare the ends of the shielded cable. This process will be repeated four times, at both ends of both input cables (although the cables will have different overall lengths).

1. Cut the shielded cable to the overall required length.
2. Use a utility knife with a new, sharp blade to cut the plastic jacket of the shielded cable 1" back from the end. Hold the blade perpendicular to the cable, and draw it across the cable lightly as you rotate the cable along its long dimension. This creates a scored line through the plastic jacket. With a sharp blade, not much pressure is needed. You may need a bit of practice to get the feel.



3. If you've scored the jacket carefully, you can separate the jacket at the score line without using tools. Pull the insulating jacket off, exposing the cable, showing the foil shield, the drain wire, and the fuzzy string. The result is shown here, with the foil shield showing.



4. Cut off the fuzzy string



5. Separate and twist the drain wire.



6. Peel back and remove the foil. Remove the plastic wrap from the red and black wires. The drain (bare wire), red, and black wires are exposed now that gray insulating jacket, foil shield, and plastic over-wrap have been removed.
7. Pull the black wire out of the shielded cable.



8. Locate the #18 solid black wire in the wire kit. Remove 5/8" of the black insulation.
9. Slip the insulation from the previous step over the drain wire. This should leave 3/8" of bare drain wire exposed. It works best if you twist the insulation in the same direction as the drain strands are twisted. If it's difficult to get it started, then cut off a little bit of the end of the drain wire. That gives you a clean end, making it easier to start the insulation onto the drain wire.
10. Remove 3/8" of insulation from the red wire. Twist its strands tightly. Twist and tin the ends of the red wire and the drain wire.
11. Repeat the end preparation process for the other end of the shielded cable.



**Figure 47- Shield wire end prep completed**

Note – the “black wire” you see in Figure 47 is the really the drain wire covered by insulation taken from the 18 AWG solid black wire.